

APPENDIX 3b

Cultural Report (2020)

HISTORICAL/ARCHAEOLOGICAL RESOURCES SURVEY REPORT

CITY CREEK CHANNEL PROJECT

**Cities of San Bernardino and Highland
San Bernardino County, California**

For Submittal to:

Inland Valley Development Agency
1601 E. Third Street, Suite 100
San Bernardino, CA 92408

Prepared for:

Tom Dodson and Associates
2150 N. Arrowhead Avenue
San Bernardino, CA 92405

Prepared by:

CRM TECH
1016 E. Cooley Drive, Suite A/B
Colton, CA 92324

Bai "Tom" Tang, Principal Investigator
Michael Hogan, Principal Investigator

January 30, 2020
CRM TECH Contract No. 3553

Title: Historical/Archaeological Resources Survey Report: City Creek Channel Project, Cities of San Bernardino and Highland, San Bernardino County, California

Author(s): Bai “Tom” Tang, Principal Investigator
Deirdre Encarnación, Archaeologist/Report Writer
Daniel Ballester, Archaeologist/Field Director
Nina Gallardo, Archaeologist/Native American Liaison
Ben Kerridge, Archaeologist

Consulting Firm: CRM TECH
1016 E. Cooley Drive, Suite A/B
Colton, CA 92324
(909) 824-6400

Date: January 30, 2020

For Submittal to: Inland Valley Development Agency
1601 E. Third Street, Suite 100
San Bernardino, CA 92408
(909) 382-4100

Prepared for: Tom Dodson and Associates
2150 N. Arrowhead Avenue
San Bernardino, CA 92405
(909) 882-3612

USGS Quadrangle: Redlands and San Bernardino South, Calif., 7.5’ quadrangles (Rancho San Bernardino land grant; T1S R3-4W, San Bernardino Baseline and Meridian)

Project Size: Approximately three linear miles

Keywords: Eastern San Bernardino Valley; Phase I historical/archaeological resources survey; 36-006848 (CA-SBR-6848H): Cram and van Leuven Ditch, circa 1858/1865; 36-033079: City Creek Channel, circa 1940-1941; PSBR-27H: North Fork Ditch, circa 1856; P1074-97H: McKenzie Ditch, circa 1856; P1074-99H: Whitlock Ditch, circa 1890s; no “historical resources” affected

EXECUTIVE SUMMARY

Between October 2019 and January 2020, at the request of Tom Dodson and Associates, CRM TECH performed a cultural resources study for the proposed City Creek Channel Project in the Cities of San Bernardino and Highland, San Bernardino County, California. The primary subject of the study is a three-mile-long segment of the existing City Creek Channel between Warm Creek on the west and Victoria Avenue on the east. The maximum width of the project area is approximately 80 feet, including 15 feet for an access road along each side of the channel where sufficient space is available. The project alignment extends across a portion of the Rancho San Bernardino land grant lying with Township 1 South, Ranges 3 and 4 West, San Bernardino Baseline and Meridian.

The study is part of the environmental review process for the project, which entails various proposed improvements to the City Creek Channel. The Inland Valley Development Agency (IVDA), as the lead agency for the project, initiated the study in compliance with the California Environmental Quality Act (CEQA). The purpose of the study is to provide IVDA with the necessary information and analysis to determine whether the project would cause substantial adverse changes to any “historical resources,” as defined by CEQA, that may exist within the project area. In order to identify such resources, CRM TECH conducted a historical/archaeological resources records search, initiated a Native American Sacred Lands File search, pursued historical background research, and carried out a systematic field survey of the entire project area.

The results of these research procedures indicate that two recorded historical/archaeological sites and three “pending” sites were previously identified as lying within or partially within the project area, as listed below:

36-006848 (CA-SBR-6848H)	Cram and van Leuven Ditch, circa 1858/1865
36-033079	Segments of City Creek Channel, circa 1940-1941
P1074-97H	“Pending” site: McKenzie Ditch, circa 1856
P1074-99H	“Pending” site: Whitlock Ditch, circa 1890s
PSBR-27H	“Pending” site: North Fork Ditch, circa 1856

During the field survey, no remnants were found of Sites 36-006848, P1074-97H, P1074-99H, and PSBR-27H, the four irrigation ditches that once crossed the project area. Furthermore, historical sources suggest that the Cram and van Leuven Ditch in fact did not cross the project area, either before or after it was extended to take over the function of the North Fork Ditch in 1865. In light of the drastic changes in the landscape since their abandonment, especially during and after World War II, it is clear that all physical traces of these early irrigation works have been obliterated by later development, at least in the immediate vicinity of this project.

The one remaining site, 36-033079, representing the City Creek Channel itself, was previously determined not to be eligible for listing in the California Register of Historical Resources, and the present study concurs to that evaluation despite the expansion of the site boundary to include the entire length of the channel within the project area. Therefore, it does not meet the definition of a “historical resource” under CEQA provisions.

No other potential “historical resources” were encountered within the project area throughout the course of the study. However, the State of California Native American Heritage Commission states that the Sacred Lands File search indicated the presence of unspecified Native American cultural resource(s) in the general vicinity of the project location and refers further inquiry to the nearby San Manuel Band of Mission Indians. According to CEQA guidelines, the identification of “tribal cultural resources” is beyond the scope of this study and needs to be addressed through government-to-government consultations between IVDA and the pertinent Native American groups pursuant to Assembly Bill (AB) 52.

Based on these findings, CRM TECH recommends to IVDA a conclusion of *No Impact* regarding cultural resources, pending completion of the AB 52 consultation process to ensure the proper identification of potential “tribal cultural resources.” No additional cultural resources investigation is recommended for the project unless construction plans undergo such changes as to include areas not covered by this study. If buried cultural materials are encountered during any earth-moving operations associated with the project, all work in the immediate area should be halted or diverted until a qualified archaeologist can evaluate the nature and significance of the finds.

TABLE OF CONTENTS

EXECUTIVE SUMMARY	i
INTRODUCTION	1
SETTING.....	4
Current Natural Setting.....	4
Cultural Setting.....	4
Prehistoric Context.....	4
Ethnohistoric Context	5
Historic Context	6
RESEARCH METHODS	7
Records Search.....	7
Sacred Lands File Search.....	7
Historical Research	8
Field Survey	8
RESULTS AND FINDINGS	8
Records Search.....	8
Sacred Lands File Search.....	10
Historical Research	10
Field Survey	12
DISCUSSION.....	14
CONCLUSION AND RECOMMENDATIONS	16
REFERENCES	16
APPENDIX 1: Personnel Qualifications	19
APPENDIX 2: Sacred Lands File Search.....	23
APPENDIX 3: Previously Identified Cultural Resources in the Project Area	29

LIST OF FIGURES

Figure 1. Project vicinity.....	1
Figure 2. Project area	2
Figure 3. Aerial view of the project area	3
Figure 4. Current conditions of the City Creek Channel	4
Figure 5. Previous cultural resources studies.....	9
Figure 6. The project area and vicinity in 1893-1899.....	11
Figure 7. The project area and vicinity in 1936-1939.....	12
Figure 8. The project area and vicinity in 1952-1954.....	13
Figure 9. Typical bridges and culverts along the City Creek Channel	14

INTRODUCTION

Between October 2019 and January 2020, at the request of Tom Dodson and Associates, CRM TECH performed a cultural resources study for the proposed City Creek Channel Project in the Cities of San Bernardino and Highland, San Bernardino County, California (Fig. 1). The primary subject of the study is a three-mile-long segment of the existing City Creek Channel between Warm Creek on the west and Victoria Avenue on the east (Figs. 2, 3). The maximum width of the project area is approximately 80 feet, including 15 feet for an access road along each side of the channel where sufficient space is available. The project alignment extends across a portion of the Rancho San Bernardino land grant lying with Township 1 South, Ranges 3 and 4 West, San Bernardino Baseline and Meridian.

The study is part of the environmental review process for the project, which entails various proposed improvements to the City Creek Channel. The Inland Valley Development Agency (IVDA), as the lead agency for the project, initiated the study in compliance with the California Environmental Quality Act (CEQA; PRC §21000, et seq.). The purpose of the study is to provide IVDA with the necessary information and analysis to determine whether the project would cause substantial adverse changes to any “historical resources,” as defined by CEQA, that may exist within the project area.

In order to identify such resources, CRM TECH conducted a historical/archaeological resources records search, initiated a Native American Sacred Lands File search, pursued historical background research, and carried out a systematic field survey of the entire project area. The following report is a complete account of the methods, results, and final conclusion of the study. Personnel who participated in the study are named in the appropriate sections below, and their qualifications are provided in Appendix 1.

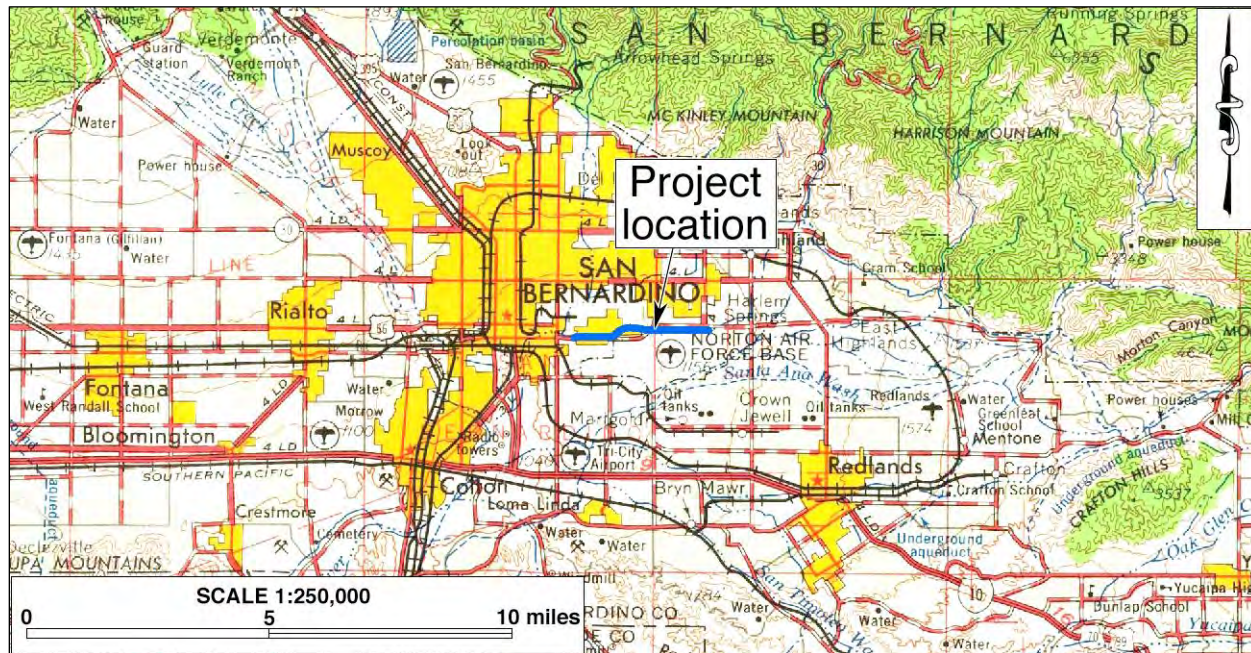

Figure 1. Project vicinity. (Based on USGS San Bernardino, Calif., 120'x60' quadrangle [USGS 1969])

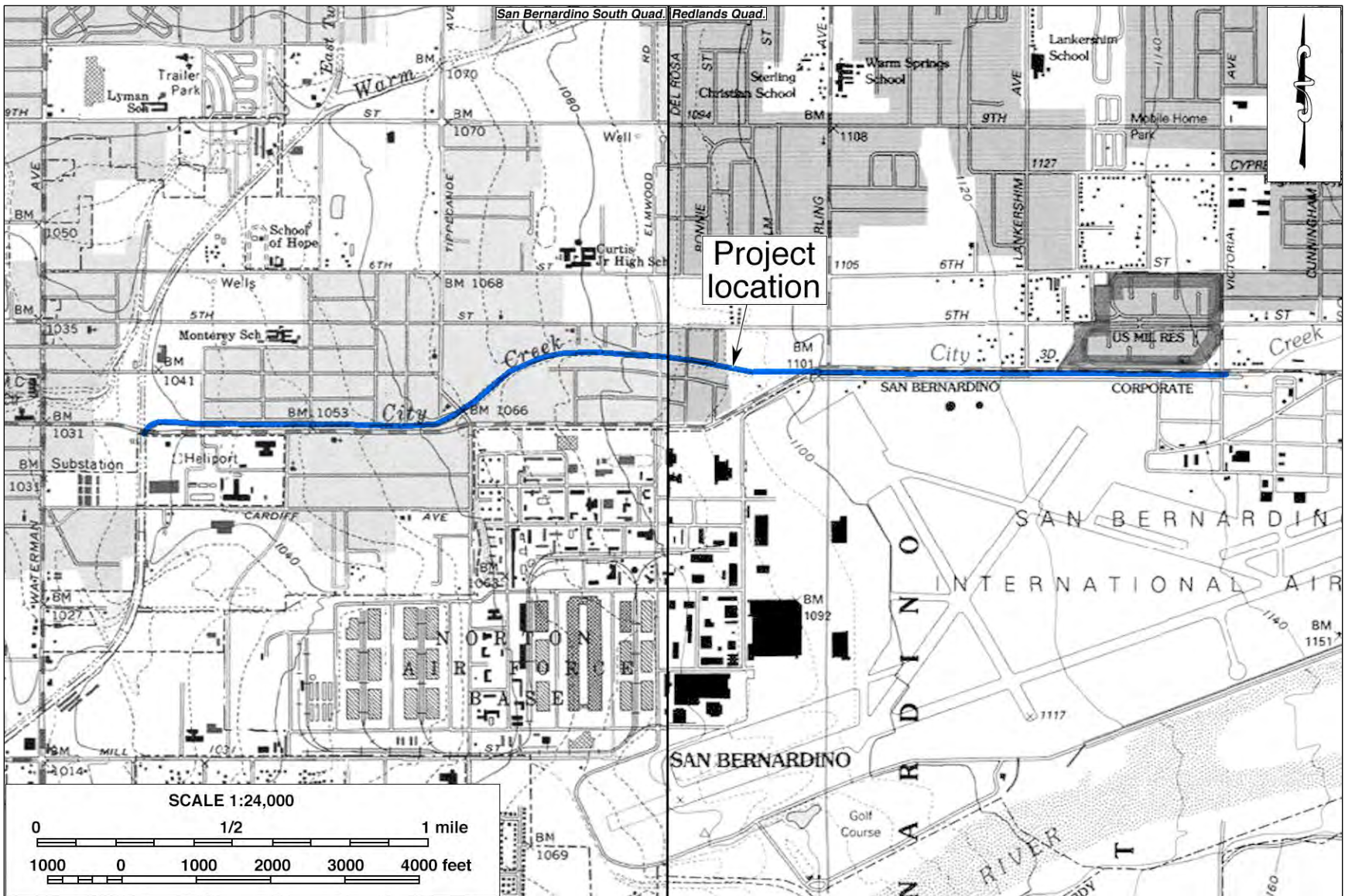

Figure 2. Project area. (Based on USGS San Bernardino South and Redlands, Calif., 7.5' quadrangles [USGS 1980; 1996])



Figure 3. Aerial view of the project area.

SETTING

CURRENT NATURAL SETTING

The project location is in the eastern end of the San Bernardino Valley, a broad inland valley defined by the San Gabriel and San Bernardino Mountain Ranges on the north and a series of low rocky hills on the south. The natural environment of the region is characterized by its temperate Mediterranean climate, with the average maximum temperature in July reaching above 90°F and the average minimum temperature in January hovering around 35°F. Rainfall is typically less than 20 inches annually, most of which occurs between November and March.

Situated in a largely urbanized setting, the project route is flanked mainly by residential neighborhoods and vacant land, with some commercial and light industrial properties also adjacent and the San Bernardino International Airport (formerly Norton Air Force Base) occupying most of the land on the south side toward the eastern end. The existing City Creek Channel is lined with concrete for the easternmost one mile, where it runs between the airport and Third Street, and at the western end just before it merges into the Warm Creek Channel (Fig. 4). The rest of the channel features unlined earthen banks, sometimes with fencing and netting along the course (Fig. 4).

The terrain along the project route is relatively level except for the four- to six-foot depth of the channel, with a gradual incline to the east. The elevations range approximately from 1,025 feet to 1,140 feet above mean sea level. Surface soils in the vicinity consist of light greyish medium- to coarse-grained sands mixed with small to large rocks and small boulders. Vegetation observed within project boundaries includes foxtail, tumbleweed, wild mustard, tree tobacco, jimsonweed, and other small grasses and shrubs.

CULTURAL SETTING

Prehistoric Context

The earliest evidence of human occupation in inland southern California was discovered below the surface of an alluvial fan in the northern portion of the Lakeview Mountains, overlooking the San Jacinto Valley, with radiocarbon dates clustering around 9,500 B.P. (Horne and McDougall 2008).



Figure 4. Current conditions of the City Creek Channel. *Left*: concrete-lined channel near Victoria Avenue, view to the east; *right*: earthen channel in the middle portion, view to the west. (Photographs taken on December 10, 2019)

Another site found near the shoreline of Lake Elsinore, close to the confluence of Temescal Wash and the San Jacinto River, yielded radiocarbon dates between 8,000 and 9,000 B.P. (Grenda 1997). Additional sites with isolated Archaic dart points, bifaces, and other associated lithic artifacts from the same age range have been found in the nearby Cajon Pass area, typically atop knolls with good viewsheds (Basgall and True 1985; Goodman and McDonald 2001; Goodman 2002; Milburn et al. 2008).

The cultural history of southern California has been summarized into numerous chronologies, including the works of Chartkoff and Chartkoff (1984), Warren (1984), and others. The prehistory of Riverside County specifically has been addressed by O'Connell et al. (1974), McDonald, et al. (1987), Keller and McCarthy (1989), Grenda (1993), Goldberg (2001), and Horne and McDougall (2008). Although the beginning and ending dates of different cultural horizons vary regionally, the general framework of the prehistory of inland southern California can be divided into three primary periods:

- Paleoindian Period (ca. 18,000-9,000 B.P.): Native peoples of this period created fluted spearhead bases designed to be hafted to wooden shafts. The distinctive method of thinning bifaces and spearhead preforms by removing long, linear flakes leaves diagnostic Paleoindian markers at tool-making sites. Other artifacts associated with the Paleoindian toolkit include choppers, cutting tools, retouched flakes, and perforators. Sites from this period are very sparse across the landscape and most are deeply buried.
- Archaic Period (ca. 9,000-1,500 B.P.): Archaic sites are characterized by abundant lithic scatters of considerable size with many biface thinning flakes, bifacial preforms broken during manufacture, and well-made groundstone bowls and basin metates. As a consequence of making dart points, many biface thinning waste flakes were generated at individual production stations, which is a diagnostic feature of Archaic sites.
- Late Prehistoric Period (ca. 1,500 B.P.-contact): Sites from this period typically contain small lithic scatters from the manufacture of small arrow points, expedient groundstone tools such as tabular metates and unshaped manos, wooden mortars with stone pestles, acorn or mesquite bean granaries, ceramic vessels, shell beads suggestive of extensive trading networks, and steatite implements such as pipes and arrow shaft straighteners.

Ethnohistoric Context

The San Bernardino-Highland area is generally considered a part of the homeland of the Serrano Indians, which is centered in the San Bernardino Mountains. Together with that of the Vanyume people, linguistically a subgroup, the traditional territory of the Serrano also includes part of the San Gabriel Mountains, much of the San Bernardino Valley, and the Mojave River valley in the southern portion of the Mojave Desert, reaching as far east as the Cady, Bullion, Sheep Hole, and Coxcomb Mountains. The name "Serrano" was derived from a Spanish term meaning "mountaineer" or "highlander." The basic written sources on Serrano culture are Kroeber (1925), Strong (1929), and Bean and Smith (1978). The following ethnographic discussion of the Serrano people is based mainly on these sources.

Prior to European contact, Serrano subsistence was defined by the surrounding landscape and primarily based on the gathering of wild and cultivated foods and hunting, exploiting nearly all of

the resources available. The population settled mostly on elevated terraces, hills, and finger ridges near where flowing water emerged from the mountains. They were loosely organized into exogamous clans led by hereditary heads, and the clans were in turn affiliated with one of two exogamous moieties named for the wildcat, *Tukutam*, and the coyote, *Wahiiam*. The exact nature of the clans, their structure, function, and number are not known, except that each clan was the largest autonomous political and landholding unit. The core of the unit was the patrilineage, although women retained their own lineage names after marriage. There was no pan-tribal political union among the clans, but they shared strong trade, ceremonial, and marital connections that sometimes also extended to other surrounding nations, such as the Kitanemuk, the Tataviam, and the Cahuilla.

The Serrano had a variety of technological skills that they used to acquire food, shelter, and clothing but also to create ornaments and decorations. Common tools included manos and metates, mortars and pestles, hammerstones, fire drills, awls, arrow straighteners, and stone knives and scrapers. These lithic tools were made from locally sourced material as well as materials procured through trade or travel. They also used wood, horn, and bone spoons and stirrers; baskets for winnowing, leaching, grinding, transporting, parching, storing, and cooking; and pottery vessels for carrying water, storage, cooking, and serving food and drink. Much of this material cultural, elaborately decorated, does not survive in the archaeological record. As usual, the main items found archaeologically relate to subsistence activities.

Although contact with Europeans may have occurred as early as 1771 or 1772, Spanish influence on Serrano lifeways was negligible until the 1810s, when a mission *asistencia* was established on the southern edge of Serrano territory. Between then and the end of the mission era in 1834, most of the Serrano in the western portion of their traditional territory were removed to the nearby missions. In the eastern portion, a series of punitive expeditions in 1866-1870 resulted in the death or displacement of almost all remaining Serrano population in the San Bernardino Mountains. Today, most Serrano descendants are affiliated with the San Manuel Band of Mission Indians, the Morongo Band of Mission Indians, or the Serrano Nation of Indians.

Historic Context

The San Bernardino Valley, along with the rest of Alta California, was claimed by Spain in the late 18th century, and the first European explorers traveled through the area as early as 1772, three years after the beginning of Spanish colonization (Beck and Haase 1974:15). For nearly four decades afterwards, however, the arid inland valley received little attention from the European colonizers, who concentrated their efforts along the Pacific coast. Following the establishment of Mission San Gabriel in 1771, the San Bernardino Valley became a part of the mission's vast land holdings. The name "San Bernardino" was bestowed on the region in the 1810s, when the *asistencia* and an associated mission rancho, both bearing that name, were established in present-day Loma Linda (Lerch and Haenszel 1981).

After gaining independence from Spain in 1821, the Mexican authorities began in 1834 the process of secularization to dismantle the mission system in Alta California. During the next 12 years, former mission ranchos throughout Alta California were surrendered to the Mexican government, and subsequently divided and granted to various prominent citizens of the province. In 1842, the former mission rancho of San Bernardino was granted to members of a prominent Los Angeles family, the Lugos (Schuiling 1984:34).

After the American annexation of Alta California in 1848, the Lugos sold the entire San Bernardino land grant in 1851 to a group of Mormon settlers, who promptly founded the town of San Bernardino, one of the first non-Indian settlements in what is known today as the Inland Empire (Schuiling 1984:45). The early growth of the Mormon colony was promising. It became the county seat of the newly created San Bernardino County in 1853 and was incorporated as a city the next year (*ibid.*:48-49). In 1857, however, the budding town suffered a devastating setback when half its population, responding to a recall from Mormon leaders, left California for Utah, causing the city to disincorporate (*ibid.*:50).

In the 1880s, spurred by the completion of the Santa Fe Railway in 1885, the rise of the profitable citrus industry, and a general land boom that swept through much of southern California, San Bernardino gradually recovered and reincorporated in 1886. With the selection of the city by the Santa Fe Railway as its regional headquarters, San Bernardino embarked on a period of steady growth that lasted well into the 20th century. During World War II, the growth of San Bernardino was further boosted when a U.S. Army Air Corps pilot training base was established in the southeastern portion of the city in 1941 (Richards 1966). Renamed Norton Air Force Base in 1950, the large military installation continued to provide an important driving force in the local economy over the next 45 years until it was closed in 1994.

A few miles to the northeast of San Bernardino, the present-day Highland area received the earliest Euroamerican settlers at least by the mid-1850s (Richards 1966). The name “Highland” was adopted by the settlers in 1883, when the area had a large enough population to warrant the establishment of a school district, and the town of Highland was laid out in 1891 (*ibid.*). During much of the 20th century, Highland remained a small rural settlement best known for citrus cultivation. In recent decades, however, like many other former rural towns in southern California, Highland has experienced rapid growth as a bedroom community, culminating in its incorporation in 1987.

RESEARCH METHODS

RECORDS SEARCH

On November 5, 2019, CRM TECH archaeologist Ben Kerridge conducted the historical/archaeological resources records search at the South Central Coastal Information Center (SCCIC), California State University, Fullerton. During the records search, Kerridge examined maps and records on file at the SCCIC for previously identified cultural resources in or near the project area and existing cultural resources reports pertaining to the vicinity. Previously identified historical/archaeological resources include properties designated as California Historical Landmarks, Points of Historical Interest, or San Bernardino County Historical Landmarks, as well as those listed in the National Register of Historic Places, the California Register of Historical Resources, or the California Historical Resources Inventory.

SACRED LANDS FILE SEARCH

On October 25, 2019, CRM TECH submitted a written request to the State of California Native American Heritage Commission (NAHC) for a records search in the commission’s Sacred Lands

File. NAHC is the State of California’s trustee agency for the protection of “tribal cultural resources,” as defined by California Public Resources Code §21074, and is tasked with identifying and cataloging properties of Native American cultural value, including places of special religious, spiritual, or social significance and known graves and cemeteries throughout the state. The response from NAHC is summarized below and attached to this report in Appendix 2.

HISTORICAL RESEARCH

Historical background research for this study was conducted by CRM TECH principal investigator/historian Bai “Tom” Tang. Sources consulted during the research included published literature in local and regional history, the U.S. General Land Office (GLO) land survey plat maps dated 1858-1876, U.S. Geological Survey (USGS) topographic maps dated 1901-1996, and aerial photographs taken in 1938-2019. The historic maps are collected at the Science Library of the University of California, Riverside, and the California Desert District of the U.S. Bureau of Land Management, located in Moreno Valley. The aerial photographs are available at the Nationwide Environmental Title Research (NETR) Online website and through the Google Earth software.

FIELD SURVEY

On December 10, 2019, CRM TECH archaeologist Daniel Ballester carried out the systematic field survey of the project area. The entire project area was surveyed on foot by walking along the banks of the channel and visually inspecting the ground surface for any indications of potential cultural resources. In the portion of the project area where the channel remains unlined, Ballester walked additional survey transects across the bottom and sidewalls of the channel to inspect the ground surface more intensively.

Using these methods, the project area was surveyed systematically for any evidence of human activities dating to the prehistoric or historic period (i.e., 45 years or older). Ground visibility ranged from poor to fair (30 to 70%) at the time of the survey, depending upon the density of the vegetation growth and the presence of other ground cover, such as refuse deposits. In light of the extent of past ground disturbances in the project area, the level of survey efforts and the ground visibility were considered adequate for this study.

RESULTS AND FINDINGS

RECORDS SEARCH

According to SCCIC records, portions of the project area, mostly near the eastern end, were included in at least 12 previous cultural resources studies completed between 1979 and 2019 (Fig. 5), but the project area as a whole had not been surveyed systematically prior to this study. As a result of these and other similar studies in the vicinity, two recorded historical/archaeological sites and three “pending” sites have been identified as lying within or partially within the project area, including two small segments of the City Creek Channel itself. These five sites are listed below (see App. 3 for further information):

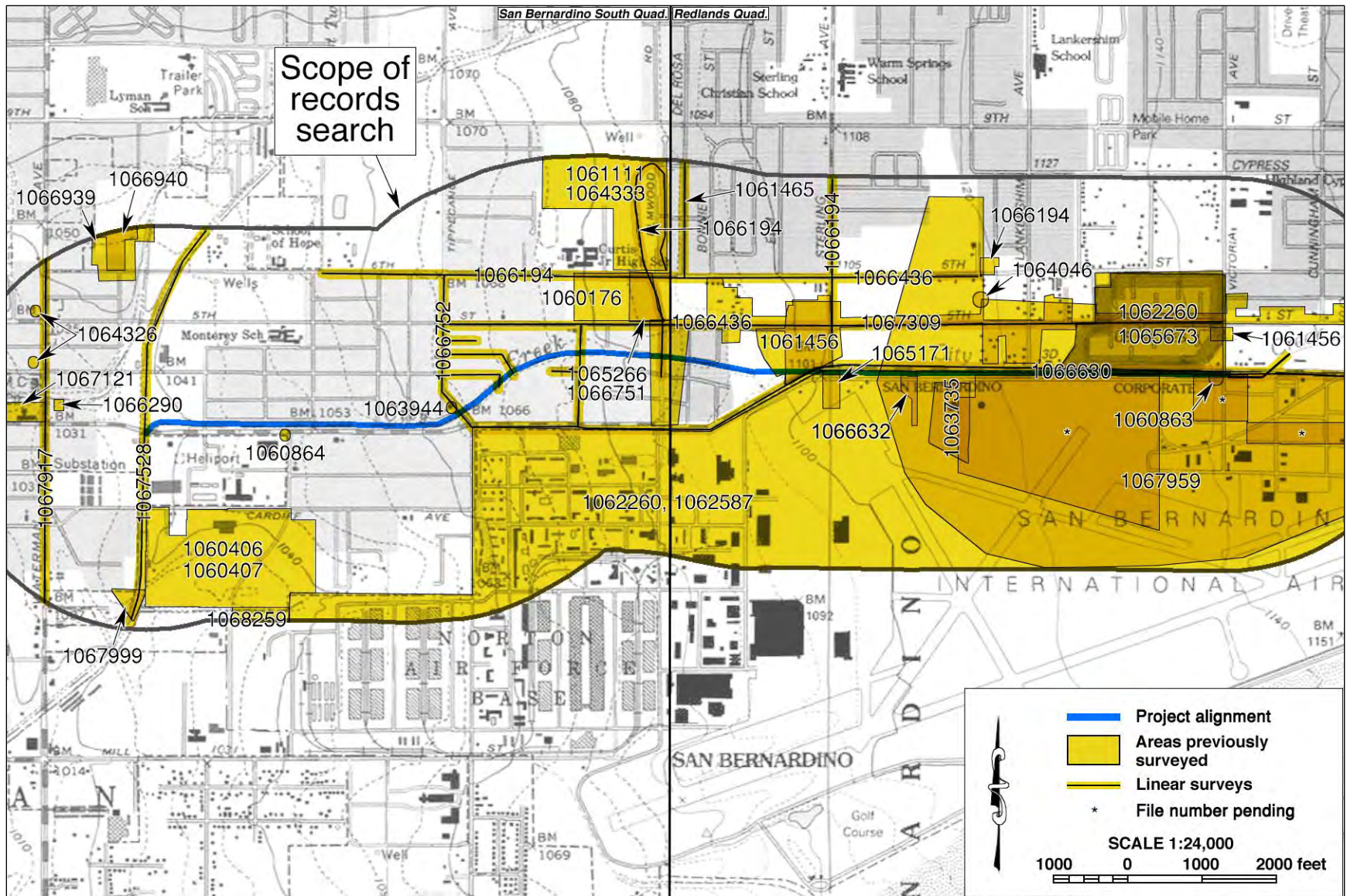

Figure 5. Previous cultural resources studies in the vicinity of the project area, listed by SCCIC file number. Locations of historical/archaeological resources are not shown as a protective measure.

36-006848 (CA-SBR-6848H)	Cram and van Leuven Ditch, circa 1858/1865
36-033079	Segments of City Creek Channel, circa 1940-1941
P1074-97H	“Pending” site: McKenzie Ditch, circa 1856
P1074-99H	“Pending” site: Whitlock Ditch, circa 1890s
PSBR-27H	“Pending” site: North Fork Ditch, circa 1856

The five known sites were subsequently included in the scope of the historical background research and the field survey, as discussed below. Outside the project area but within a half-mile radius, SCCIC records show roughly 30 other previous studies on various tracts of land and linear features (Fig. 5). These studies resulted in the identification of nearly 130 recorded sites and six “pending” sites within the scope of the records search, in addition to those listed above. Only two of the sites were of prehistoric (i.e., Native American) origin. Site 36-002794 consisted of a collection of mortars and metates discovered during construction, and Site 36-001074 was described as a small lithic scatter with ten flakes, but the locations of these sites are not clearly defined in the existing records.

The rest of the sites dated to the historic period and consisted predominantly of buildings, including many associated with Norton Air Force Base. Other historic-period sites in the vicinity included various linear features of infrastructure, such as roads and irrigation ditches. None of these additional sites was found within the area to be impacted by the proposed project, and thus none of them requires further consideration during this study.

SACRED LANDS FILE SEARCH

In response to CRM TECH’s inquiry, the Native American Heritage Commission states in a letter dated October 29, 2019, that the Sacred Lands File identified unspecified Native American cultural resource or resources in the general vicinity of the project area. NAHC recommended that the San Manuel Band of Mission Indians near Highland be contacted for additional information and provided a list of other local Native American groups who may also have knowledge of such resource(s) for further consultation. NAHC’s reply is attached to this report in Appendix 2 for reference by IVDA in future government-to-government consultations with the local Native American tribes.

HISTORICAL RESEARCH

Historical sources offered ample evidence of settlement and development activities in the project vicinity during the mid- and late 19th century. As early as the mid-1850s, several Mormon settlements were known to have been established on the former Rancho San Bernardino, in addition to the main townsite bearing that name (Scott 1977:12). One of these, the City Creek Settlement, was located in the area along present-day Sixth Street between Waterman Avenue and Sterling Avenue, ¼ to ½ mile north of the project location (*ibid.*). The North Fork Ditch (PSBR-27H), a short irrigation ditch built in 1856 from the Santa Ana River, served as the settlement’s main water supply line and evidently crossed the project area near the eastern end (*ibid.*:12, 13).

After a catastrophic flood on the Santa Ana River in 1862 rendered the original North Fork Ditch useless, the nearby Cram and van Leuven Ditch (36-006848), which had been built in 1858 further upstream but had terminated before reaching the project area, was enlarged and lengthened to

convey water allotted to the City Creek Settlement as well (Scott 1977:14-16). The new ditch, completed in 1865, inherited the name of the North Fork Ditch but no longer crossed the project area, traversing east-west near Sixth Street instead (*ibid.*:15-16). In 1881-1882, a “highline ditch” was built along the base of the San Bernardino Mountains to maximize the area irrigated and became known as the North Fork Canal (*ibid.*:17). After that, the 1865 alignment of the combined North Fork Ditch and Cram and van Leuven Ditch near the project area was presumably abandoned.

The other two ditches known to have been once located across the project area, the McKenzie Ditch (P1074-97H) and the Whitlock Ditch (P1074-99H), were both relatively minor irrigation works. The McKenzie Ditch was built around 1856 to divert water from Warm Creek and ran south near present-day Tippecanoe Avenue to irrigate land on both sides of City Creek, crossing the latter by way of a wooden flume (Scott 1977:52, 55). The diminishing flow in Warm Creek and the subdivision of its service area for residential development eventually resulted in the abandonment of that ditch prior to the sale of the water rights to irrigators in Riverside in 1943 (*ibid.*:56). The Whitlock Ditch, a very short ditch that diverted from the north side of City Creek and discharged the surplus water into the McKenzie Ditch, is known to have been in use in 1898, but little further information is available on its history (*ibid.*:52, 58).

By the 1890s, a large number of buildings, most of them likely farmsteads, had appeared around the project location, and a grid of roads had been established, including the forerunners of Third Street, Victoria Avenue, Lankershim Avenue, Sterling Avenue, and Tippecanoe Avenue (Fig. 6). In the 1930s, the road along the eastern portion of the project area was named City Creek Road, while the original alignment of Third Street ran parallel to the south (Fig. 7; NETR Online 1938). Notably, the course of City Creek, then a wide, unregulated wash, did not coincide with the present-day channel along the entire route but traversed further to the south in the eastern reach (Fig. 7; NETR Online 1938). That segment of the channel evidently resulted from the construction of what would become Norton Air Force Base in 1940-1941 (Richards 1966; Norton Air Force Base Museum n.d.).

In the 1950s, both Third Street and City Creek were clearly shown to have been realigned to their current courses outside the northern boundary of Norton Air Force Base, with Third Street absorbing the former City Creek Road (Fig. 8; NETR Online 1959). By then, the eastern segment of the channel had apparently been lined with concrete, while the western reach of City Creek had also been channelized but left unlined as it is today (NETR Online 1959). The channel at the western end of the project area was realigned between 1959 and 1966, when the Warm Creek Channel was



Figure 6. The project area and vicinity in 1893-1899. (Source: USGS 1901a; 1901b)

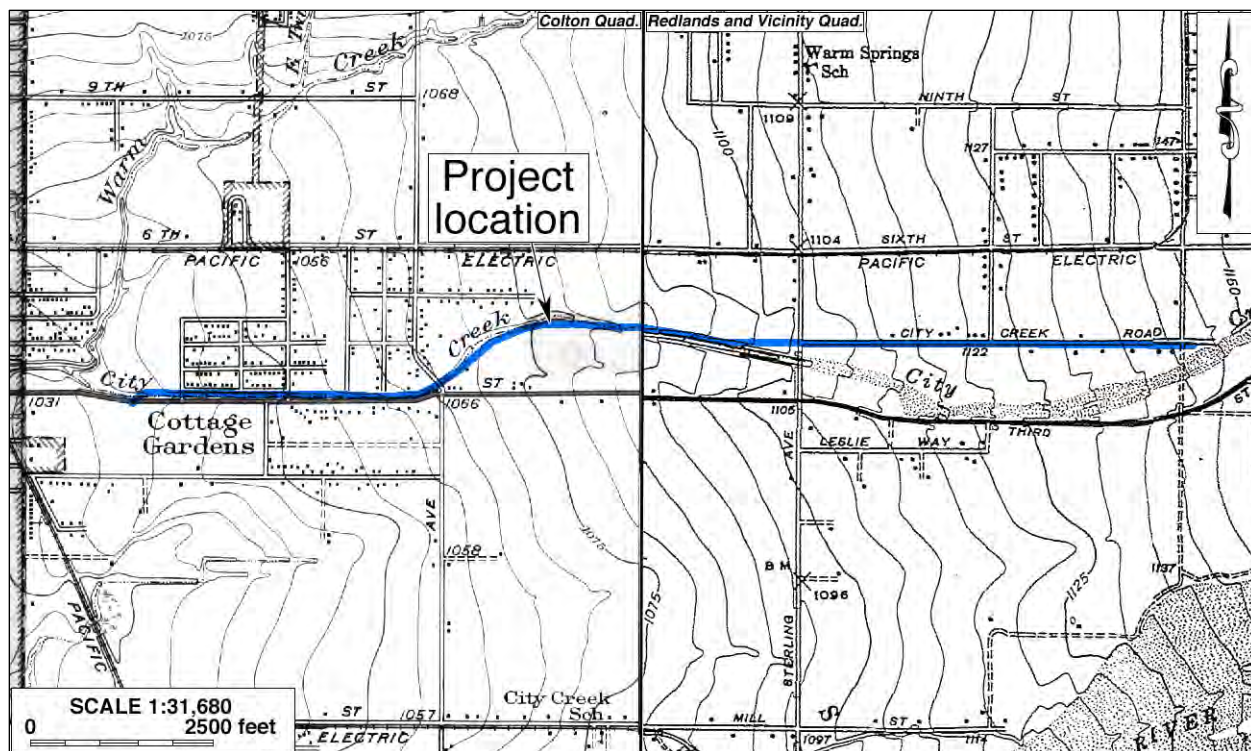

Figure 7. The project area and vicinity in 1936-1939. (Source: USGS 1943a; 1943b)

completely reconfigured (NETR Online 1959; 1966), and the segment extending east from the project area was converted into an underground culvert in 2012-2013, in preparation for the extension of Victoria Avenue onto the former military base in 2014-2016 (Google Earth 2012-2016). The rest of the City Creek Channel in and near the project area has undergone no major changes since 1959 except for the extension of Del Rosa Drive across it sometime between 1968 and 1980 (NETR Online 1959-2016; Google Earth 1996-2019).

FIELD SURVEY

The results of the field survey indicate that the existing City Creek Channel (Site 36-033079) is the only cultural resource of historical or prehistoric origin that is present within the project area today. No remnants were found of the four irrigation ditches that once crossed the project area, namely the Cram and van Leuven Ditch, the McKenzie Ditch, the Whitlock Ditch, and the North Fork Ditch (Sites 36-006848, P1074-97H, P1074-99H, and PSBR-27H). In light of the drastic changes in the landscape since their abandonment, especially during and after World War II, it is clear that all physical traces of these early irrigation works have been obliterated by later development, at least in the immediate vicinity of this project.

Site 36-033079 was originally recorded in 2018 as an approximately 2,480-foot segment of the City Creek Channel near the intersection of Victoria Avenue, and a 700-foot segment at Victoria Avenue crossing was added to the site in 2019 (see App. 3). As a result of the current survey, the site was extended further to the west to encompass the entire project alignment to its confluence with the Warm Creek Channel (see App. 3). As mentioned above, the easternmost one mile of the channel is

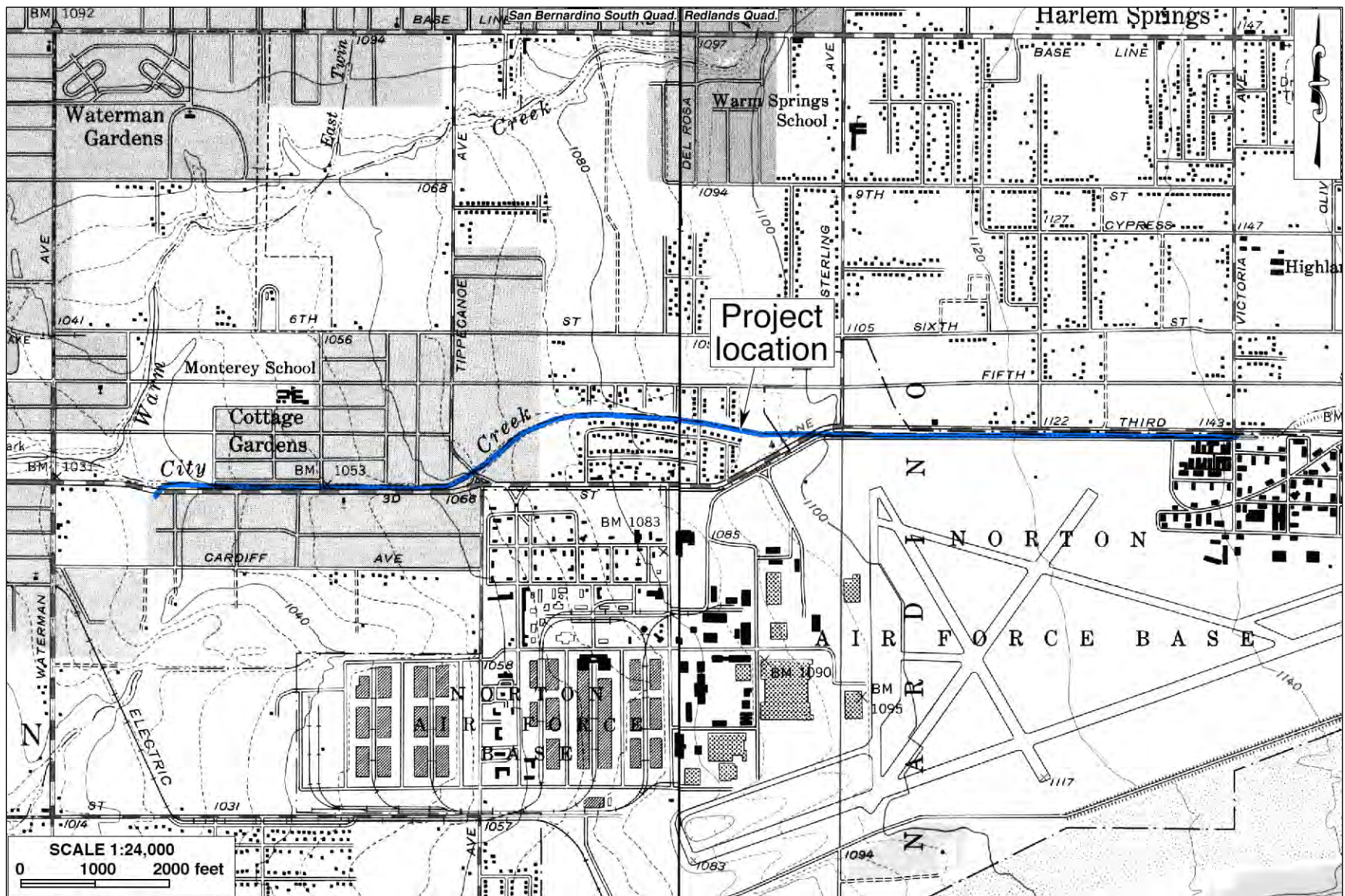

Figure 8. The project area and vicinity in 1952-1954. (Source: USGS 1954a; 1954b)

lined with concrete, as is the westernmost 600 feet, while the rest of the length remains an unlined earthen channel (Fig. 4).

A total of seven minor concrete bridges or culverts of historical age (or possibly of historical age) were recorded as associated features of the site. All of the bridges and culverts are of standard design and construction, and none of them demonstrate any notable characters in architecture or engineering (Fig. 9). These seven bridges or culverts and their construction dates are listed below:

- Third Street crossing near Sterling Avenue, pre-1959*
 - Del Rosa Avenue crossing, pre-1959*
 - Del Rosa Drive crossing, 1968-1980*
 - Tippecanoe Avenue crossing, pre-1959*
 - Pedley Road crossing, pre-1959*
 - Palm Lane crossing, pre-1959*
 - Third Street crossing near Warm Creek Channel, 1959-1966*
- * Source: NETR Online 1959-1980



Figure 9. Typical bridges and culverts along the City Creek Channel. *Clockwise from upper left:* Third Street crossing, view to the east; Del Rosa Avenue crossing, view to the southwest; Tippecanoe Avenue crossing, view to the east; Pedley Road crossing, view to the southeast. (Photographs taken on December 10, 2019)

DISCUSSION

The purpose of this study is to identify any cultural resources within the project area and assist IVDA in determining whether such resources meet the official definition of “historical resources” as provided in the California Public Resources Code, in particular CEQA. According to PRC

§5020.1(j), “‘historical resource’ includes, but is not limited to, any object, building, site, area, place, record, or manuscript which is historically or archaeologically significant, or is significant in the architectural, engineering, scientific, economic, agricultural, educational, social, political, military, or cultural annals of California.”

More specifically, CEQA guidelines state that the term “historical resources” applies to any such resources listed in or determined to be eligible for listing in the California Register of Historical Resources, included in a local register of historical resources, or determined to be historically significant by the lead agency (Title 14 CCR §15064.5(a)(1)-(3)). Regarding the proper criteria for the evaluation of historical significance, CEQA guidelines mandate that “generally a resource shall be considered by the lead agency to be ‘historically significant’ if the resource meets the criteria for listing on the California Register of Historical Resources” (Title 14 CCR §15064.5(a)(3)). A resource may be listed in the California Register if it meets any of the following criteria:

- (1) Is associated with events that have made a significant contribution to the broad patterns of California’s history and cultural heritage.
- (2) Is associated with the lives of persons important in our past.
- (3) Embodies the distinctive characteristics of a type, period, region, or method of construction, or represents the work of an important creative individual, or possesses high artistic values.
- (4) Has yielded, or may be likely to yield, information important in prehistory or history. (PRC §5024.1(c))

In summary of the research results presented above, the only potential “historical resource” identified within the project area during this study is Site 36-033079, representing the City Creek Channel itself, which was constructed in the 1940s-1950s, at least partially during the construction of Norton Air Force Base in 1940-1941. The site was previously recorded in the eastern portion of the project area in 2018 and 2019, and it was found not to be eligible for listing in the National Register of Historic Places or the California Register of Historical Resources at the time (Tang et al. 2018:16; 2019:16; Gallardo 2018:2; see App. 3). The present study expanded the site boundary to include the entire three-mile length of the channel within the project area but did not encounter any new data that would warrant a revision of the previous evaluation.

The City Creek Channel is a peripheral feature associated, at least partially, with the establishment of a WWII-era military base but does not demonstrate a unique or particularly close association with that event or with any other events or persons of recognized historic significance. Simple in design and utilitarian in character, the channel and its associated features, such as the bridges and culverts, do not stand out as important examples of any style, type, period, region, or method of construction, nor are they known to represent the work of a prominent architect, designer, engineer, or builder. Finally, as a late-historic-period infrastructure feature of standard construction, the channel demonstrates little potential for any important historical or archaeological information.

Based on these considerations, and in light of the criteria listed above, Site 36-033079 does not appear to meet any of the criteria for listing in the California Register of Historical Resources and thus does not qualify as a “historical resource.” No other potential “historical resources” of either prehistoric or historical origin were identified throughout the various avenues of research. Therefore, the present study concludes that no “historical resources” are present within the project area.

CONCLUSION AND RECOMMENDATIONS

CEQA establishes that a project that may cause a substantial adverse change in the significance of a “historical resource” or a “tribal cultural resource” is a project that may have a significant effect on the environment (PRC §21084.1-2). “Substantial adverse change,” according to PRC §5020.1(q), “means demolition, destruction, relocation, or alteration such that the significance of a historical resource would be impaired.”

In conclusion, the present study finds that the only historical/archaeological site present within the project area, 36-033079, does not constitute a “historical resource” under CEQA provisions. However, the NAHC has reported the presence of unspecified Native American cultural resource(s) in the project vicinity and referred further inquiry to the San Manuel Band of Mission Indians. According to CEQA guidelines, the identification of “tribal cultural resources” is beyond the scope of this study and needs to be addressed through government-to-government consultations between IVDA and the pertinent Native American groups pursuant to Assembly Bill (AB) 52. Therefore, CRM TECH presents the following recommendations to IVDA:

- The proposed project will not cause a substantial adverse change to any known “historical resources.”
- A tentative conclusion of *No Impact* on cultural resources appears to be appropriate for this project, pending completion of the AB 52 consultation process to ensure the proper identification of potential “tribal cultural resources.”
- No additional cultural resources investigation will be necessary for the project unless construction plans undergo such changes as to include areas not covered by this study.
- If buried cultural materials are encountered during any earth-moving operations associated with the project, all work in the immediate area should be halted or diverted until a qualified archaeologist can evaluate the nature and significance of the finds.

REFERENCES

- Basgall, Mark E., and D.L. True
1985 Archaeological Investigations in Crowder Canyon, 1973-1984: Excavations at Sites SBR-421B, SBR-421C, SBR-421D, and SBR-713, San Bernardino County, California. On file, South Central Coastal Information Center, California State University, Fullerton.
- Bean, Lowell John, and Charles R. Smith
1978 Serrano. In Robert F. Heizer (ed.): *Handbook of North American Indians*, Vol. 8: *California*; pp. 570-574. Smithsonian Institution, Washington, D.C.
- Beck, Warren A., and Ynez D. Haase
1974 *Historical Atlas of California*. University of Oklahoma Press, Norman.
- Chartkoff, Joseph L., and Kerry Kona Chartkoff
1984 *The Archaeology of California*. Stanford University Press, Stanford, California.
- Gallardo, Nina
2018 California Historical Resources Inventory record forms, Site 36-033079. On file, South Central Coastal Information Center, California State University, Fullerton.

- Goldberg, Susan K. (ed.)
 2001 Metropolitan Water District of Southern California Eastside Reservoir Project: Final Report of Archaeological Investigations. On file, Eastern Information Center, University of California, Riverside.
- Goodman, John D., II
 2002 Archaeological Survey of the Charter Communications Cable Project, Mountaintop Ranger District, San Bernardino National Forest, California. San Bernardino National Forest Technical Report 05-12-BB-102. San Bernardino.
- Goodman, John D., II, and M. McDonald
 2001 Archaeological Survey of the Southern California Trials Association Event Area, Little Pine Flats, Mountaintop Ranger District, San Bernardino National Forest, California. San Bernardino National Forest Technical Report 05-12-BB-106. San Bernardino.
- Google Earth
 1996-2019 Aerial photographs of the project vicinity; taken in 1996, 2002, 2004-2006, 2009, and 2011-2019. Available through the Google Earth software.
- Grenda, Donn
 1993 Archaeological Treatment Plan for CA-RIV-2798/H, Lake Elsinore, Riverside County, California. On file, Eastern Information Center, University of California, Riverside.
 1997 Continuity and Change: 8,500 Years of Lacustrine Adaptation on the Shores of Lake Elsinore. Statistical Research Technical Series 59. Statistical Research, Inc., Tucson, Arizona.
- Horne, Melinda C., and Dennis P. McDougall
 2008 CA-RIV-6069: Early Archaic Settlement and Subsistence in the San Jacinto Valley, Western Riverside County, California. On file, Eastern Information Center, University of California, Riverside.
- Keller, Jean S., and Daniel F. McCarthy
 1989 Data Recovery at the Cole Canyon Site (CA-RIV-1139), Riverside County, California. *Pacific Coast Archeological Society Quarterly* 25.
- Kroeber, Alfred L.
 1925 *Handbook of the Indians of California*. Bureau of American Ethnology Bulletin 78. Washington, D.C.
- Lerch, Michael K., and Arda M. Haenszel
 1981 Life on Cottonwood Row. *Heritage Tales* 1981:33-71. Fourth Annual Publication of the City of San Bernardino Historical Society, San Bernardino.
- McDonald, Meg, Philip J. Wilke, and Andrea Kauss
 1987 McCue: An Elko Site in Riverside County. *Journal of California and Great Basin Anthropology* 9(1):46-73.
- Milburn, Doug, U.K. Doan, and John D. Goodman II
 2008 Archaeological Investigation at Baldy Mesa-Cajon Divide for the Baldy Mesa Off-Highway-Vehicle Recreation Trails Project, San Bernardino National Forest, San Bernardino County, California. San Bernardino National Forest Technical Report 05-12-53-091. San Bernardino.
- NETR Online
 1938-2016 Aerial photographs of the project vicinity; taken in 1938, 1959, 1966, 1968, 1980, 1994, 2002, 2005, 2009, 2010, 2012, 2014, and 2016. <http://www.historicaerials.com>.
- Norton Air Force Base Museum
 n.d. History. <http://www.nafbmuseum.org/history/>.

- O'Connell, James F., Philip J. Wilke, Thomas F. King, and Carol L. Mix (eds.)
 1974 Perris Reservoir Archaeology: Late Prehistoric Demographic Change in Southeastern California. On file, Eastern Information Center, University of California, Riverside.
- Richards, Elizabeth W.
 1966 *Guideposts to History, Concerning Origins of Place and Street Names in San Bernardino County*. Santa Fe Federal Savings and Loan Association, San Bernardino, California.
- Schuiling, Walter C.
 1984 *San Bernardino County: Land of Contrasts*. Windsor Publications, Woodland Hills, California.
- Scott, M.B.
 1977 Development of Water Facilities in the Santa Ana River Basin California, 1810-1968. On file, South Central Coastal Information Center, California State University, Fullerton.
- Strong, William Duncan
 1929 *Aboriginal Society in Southern California*. University of California Publications in American Archaeology and Ethnology 26. Reprinted by Malki Museum Press, Banning, Calif., 1972.
- Tang, Bai "Tom," Daniel Ballester, Terri Jacquemain, and Ben Kerridge
 2019 Identification and Evaluation of Historic Properties: San Bernardino International Airport Land Exchange Project, City of San Bernardino, San Bernardino County, California. On file, South Central Coastal Information Center, California State University, Fullerton.
- Tang, Bai "Tom," Michael Hogan, Ben Kerridge, and Daniel Ballester
 2018 Identification and Evaluation of Historic Properties: Proposed Eastgate Air Cargo Facility, City of San Bernardino, San Bernardino County, California. On file, South Central Coastal Information Center, California State University, Fullerton.
- USGS (United States Geological Survey, U.S. Department of the Interior)
 1901a Map: Redlands, Calif. (15', 1:62,500); surveyed in 1898-1899.
 1901b Map: San Bernardino, Calif. (15', 1:62,500); surveyed in 1893-1894.
 1943a Map: Colton, Calif. (1:31,680); surveyed in 1936-1938.
 1943b Map: Redlands and Vicinity, Calif. (1:31,680); surveyed in 1939.
 1954a Map: Redlands, Calif. (7.5', 1:24,000); aerial photos taken in 1952, field-checked 1954.
 1954b Map: San Bernardino South, Calif. (7.5', 1:24,000); aerial photographs taken in 1952, field-checked in 1954.
 1969 Map: San Bernardino, Calif. (1:250,000); 1958 edition revised.
 1980 Map: San Bernardino South, Calif. (7.5', 1:24,000); 1967 edition photorevised in 1979.
 1996 Map: Redlands, Calif. (7.5', 1:24,000); 1967 edition photorevised in 1994.
- Warren, Claude N.
 1984 The Desert Region. In Michael J. Moratto (ed.): *California Archaeology*; pp. 339-430. Academic Press, Orlando, Florida.

**APPENDIX 1:
PERSONNEL QUALIFICATIONS**

**PRINCIPAL INVESTIGATOR/HISTORIAN
Bai “Tom” Tang, M.A.**

Education

- 1988-1993 Graduate Program in Public History/Historic Preservation, UC Riverside.
1987 M.A., American History, Yale University, New Haven, Connecticut.
1982 B.A., History, Northwestern University, Xi’an, China.
- 2000 “Introduction to Section 106 Review,” presented by the Advisory Council on Historic Preservation and the University of Nevada, Reno.
1994 “Assessing the Significance of Historic Archaeological Sites,” presented by the Historic Preservation Program, University of Nevada, Reno.

Professional Experience

- 2002- Principal Investigator, CRM TECH, Riverside/Colton, California.
1993-2002 Project Historian/Architectural Historian, CRM TECH, Riverside, California.
1993-1997 Project Historian, Greenwood and Associates, Pacific Palisades, California.
1991-1993 Project Historian, Archaeological Research Unit, UC Riverside.
1990 Intern Researcher, California State Office of Historic Preservation, Sacramento.
1990-1992 Teaching Assistant, History of Modern World, UC Riverside.
1988-1993 Research Assistant, American Social History, UC Riverside.
1985-1988 Research Assistant, Modern Chinese History, Yale University.
1985-1986 Teaching Assistant, Modern Chinese History, Yale University.
1982-1985 Lecturer, History, Xi’an Foreign Languages Institute, Xi’an, China.

Cultural Resources Management Reports

Preliminary Analyses and Recommendations Regarding California’s Cultural Resources Inventory System (with Special Reference to Condition 14 of NPS 1990 Program Review Report). California State Office of Historic Preservation working paper, Sacramento, September 1990.

Numerous cultural resources management reports with the Archaeological Research Unit, Greenwood and Associates, and CRM TECH, since October 1991.

PRINCIPAL INVESTIGATOR/ARCHAEOLOGIST
Michael Hogan, Ph.D., RPA

Education

- 1991 Ph.D., Anthropology, University of California, Riverside.
1981 B.S., Anthropology, University of California, Riverside; with honors.
1980-1981 Education Abroad Program, Lima, Peru.
- 2002 Section 106—National Historic Preservation Act: Federal Law at the Local Level.
UCLA Extension Course #888.
- 2002 “Recognizing Historic Artifacts,” workshop presented by Richard Norwood,
Historical Archaeologist.
- 2002 “Wending Your Way through the Regulatory Maze,” symposium presented by the
Association of Environmental Professionals.
- 1992 “Southern California Ceramics Workshop,” presented by Jerry Schaefer.
1992 “Historic Artifact Workshop,” presented by Anne Duffield-Stoll.

Professional Experience

- 2002- Principal Investigator, CRM TECH, Riverside/Colton, California.
1999-2002 Project Archaeologist/Field Director, CRM TECH, Riverside.
1996-1998 Project Director and Ethnographer, Statistical Research, Inc., Redlands.
1992-1998 Assistant Research Anthropologist, University of California, Riverside
1992-1995 Project Director, Archaeological Research Unit, U. C. Riverside.
1993-1994 Adjunct Professor, Riverside Community College, Mt. San Jacinto College, U.C.
Riverside, Chapman University, and San Bernardino Valley College.
1991-1992 Crew Chief, Archaeological Research Unit, U. C. Riverside.
1984-1998 Archaeological Technician, Field Director, and Project Director for various southern
California cultural resources management firms.

Research Interests

Cultural Resource Management, Southern Californian Archaeology, Settlement and Exchange
Patterns, Specialization and Stratification, Culture Change, Native American Culture, Cultural
Diversity.

Cultural Resources Management Reports

Author and co-author of, contributor to, and principal investigator for numerous cultural resources
management study reports since 1986.

Memberships

Register of Professional Archaeologists; Society for American Archaeology; Society for California
Archaeology; Pacific Coast Archaeological Society; Coachella Valley Archaeological Society.

PROJECT ARCHAEOLOGIST/REPORT WRITER
Deirdre Encarnación, M.A.

Education

- 2003 M.A., Anthropology, San Diego State University, California.
2000 B.A., Anthropology, minor in Biology, with honors; San Diego State University, California.
1993 A.A., Communications, Nassau Community College, Garden City, N.Y.
- 2001 Archaeological Field School, San Diego State University.
2000 Archaeological Field School, San Diego State University.

Professional Experience

- 2004- Project Archaeologist/Report Writer, CRM TECH, Riverside/Colton, California.
2001-2003 Part-time Lecturer, San Diego State University, California.
2001 Research Assistant for Dr. Lynn Gamble, San Diego State University.
2001 Archaeological Collection Catalog, SDSU Foundation.

Memberships

Society for California Archaeology; Society for Hawaiian Archaeology; California Native Plant Society.

PROJECT ARCHAEOLOGIST/NATIVE AMERICAN LIAISON
Nina Gallardo, B.A.

Education

- 2004 B.A., Anthropology/Law and Society, University of California, Riverside.

Professional Experience

- 2004- Project Archaeologist, CRM TECH, Riverside/Colton, California.

Cultural Resources Management Reports

Co-author of and contributor to numerous cultural resources management reports since 2004.

PROJECT ARCHAEOLOGIST/FIELD DIRECTOR
Daniel Ballester, M.S., RPA

Education

- 2013 M.S., Geographic Information System (GIS), University of Redlands, California.
- 1998 B.A., Anthropology, California State University, San Bernardino.
- 1997 Archaeological Field School, University of Las Vegas and University of California, Riverside.
- 1994 University of Puerto Rico, Rio Piedras, Puerto Rico.

Professional Experience

- 2002- Field Director/GIS Specialist, CRM TECH, Riverside/Colton, California.
- 1999-2002 Project Archaeologist, CRM TECH, Riverside, California.
- 1998-1999 Field Crew, K.E.A. Environmental, San Diego, California.
- 1998 Field Crew, A.S.M. Affiliates, Encinitas, California.
- 1998 Field Crew, Archaeological Research Unit, University of California, Riverside.

Memberships

Register of Professional Archaeologists.

PROJECT ARCHAEOLOGIST
Ben Kerridge, M.A.

Education

- 2014 Archaeological Field School, Institute for Field Research, Kephallenia, Greece.
- 2010 M.A., Anthropology, California State University, Fullerton.
- 2009 Project Management Training, Project Management Institute/CH2M HILL.
- 2004 B.A., Anthropology, California State University, Fullerton.

Professional Experience

- 2015- Project Archaeologist/Report Writer, CRM TECH, Colton, California.
- 2015 Teaching Assistant, Institute for Field Research, Kephallenia, Greece.
- 2009-2014 Publications Delivery Manager, CH2M HILL, Santa Ana, California.
- 2010- Naturalist, Newport Bay Conservancy, Newport Beach, California.
- 2006-2009 Technical Publishing Specialist, CH2M HILL, Santa Ana, California.
- 2002-2006 English Composition/College Preparation Tutor, various locations, California.

Memberships

Society for California Archaeology; Pacific Coast Archaeological Society.

APPENDIX 2
SACRED LANDS FILE SEARCH

SACRED LANDS FILE & NATIVE AMERICAN CONTACTS LIST REQUEST

NATIVE AMERICAN HERITAGE COMMISSION

915 Capitol Mall, RM 364
Sacramento, CA 95814
(916) 653-4082
(916) 657-5390 – Fax
nahc@pacbell.net

Project: Proposed City Creek Channel Project, Victoria Avenue to Twin Creek (CRM TECH No. 3553)

County: San Bernardino

USGS Quadrangle Name: Redlands and San Bernardino South, Calif.

Township 1 South **Range** 3-4 West **SB BM; Section(s):** (San Bernardino land grant)

Company/Firm/Agency: CRM TECH

Contact Person: Nina Gallardo

Street Address: 1016 E. Cooley Drive, Suite A/B

City: Colton, CA **Zip:** 92324

Phone: (909) 824-6400 **Fax:** (909) 824-6405

Email: Ngallardo@crmtech.us

Project Description: The primary component of the project is to make improvements to approximately three linear miles of the existing City Creek Channel between Victoria Avenue and Twin Creek, to the north of the San Bernardino International Airport, in the City of San Bernardino, San Bernardino County, California.

October 25, 2019

NATIVE AMERICAN HERITAGE COMMISSION
Cultural and Environmental Department
1550 Harbor Blvd., Suite 100
West Sacramento, CA 95691 Phone: (916) 373-3710
Email: nahc@nahc.ca.gov
Website: <http://www.nahc.ca.gov>



October 29, 2019

Nina Gallardo
CRM TECH

VIA Email to: ngallardo@crmtech.us

RE: Proposed City Creek Channel Project – Victoria Avenue to Twin Creek Project, San Bernardino County

Dear Ms. Gallardo:

A record search of the Native American Heritage Commission (NAHC) Sacred Lands File (SLF) was completed for the information you have submitted for the above referenced project. The results were positive. Please contact the San Manuel Band of Mission Indians on the attached list for more information. Other sources of cultural resources should also be contacted for information regarding known and recorded sites.

Attached is a list of Native American tribes who may also have knowledge of cultural resources in the project area. This list should provide a starting place in locating areas of potential adverse impact within the proposed project area. I suggest you contact all of those indicated; if they cannot supply information, they might recommend others with specific knowledge. By contacting all those listed, your organization will be better able to respond to claims of failure to consult with the appropriate tribe. If a response has not been received within two weeks of notification, the Commission requests that you follow-up with a telephone call or email to ensure that the project information has been received.

If you receive notification of change of addresses and phone numbers from tribes, please notify me. With your assistance, we can assure that our lists contain current information. If you have any questions or need additional information, please contact me at my email address: Andrew.Green@nahc.ca.gov.

Sincerely,

A handwritten signature in blue ink that reads "Andrew Green".

Andrew Green
Staff Services Analyst

Attachment

**Native American Heritage Commission
Native American Contact List
San Bernardino County
10/29/2019**

Agua Caliente Band of Cahuilla Indians

Jeff Grubbe, Chairperson
5401 Dinah Shore Drive Cahuilla
Palm Springs, CA, 92264
Phone: (760) 699 - 6800
Fax: (760) 699-6919

Gabrieleno/Tongva San Gabriel Band of Mission Indians

Anthony Morales, Chairperson
P.O. Box 693 Gabrieleno
San Gabriel, CA, 91778
Phone: (626) 483 - 3564
Fax: (626) 286-1262
GTtribalcouncil@aol.com

Agua Caliente Band of Cahuilla Indians

Patricia Garcia-Plotkin, Director
5401 Dinah Shore Drive Cahuilla
Palm Springs, CA, 92264
Phone: (760) 699 - 6907
Fax: (760) 699-6924
ACBCI-THPO@aguacaliente.net

Gabrielino /Tongva Nation

Sandonne Goad, Chairperson
106 1/2 Judge John Aiso St., Gabrielino
#231
Los Angeles, CA, 90012
Phone: (951) 807 - 0479
sgoad@gabrielino-tongva.com

Augustine Band of Cahuilla Mission Indians

Amanda Vance, Chairperson
P.O. Box 846 Cahuilla
Coachella, CA, 92236
Phone: (760) 398 - 4722
Fax: (760) 369-7161
hhaines@augustinetribe.com

Gabrielino Tongva Indians of California Tribal Council

Robert Dorame, Chairperson
P.O. Box 490 Gabrielino
Bellflower, CA, 90707
Phone: (562) 761 - 6417
Fax: (562) 761-6417
gtongva@gmail.com

Cabazon Band of Mission Indians

Doug Welmas, Chairperson
84-245 Indio Springs Parkway Cahuilla
Indio, CA, 92203
Phone: (760) 342 - 2593
Fax: (760) 347-7880
jstapp@cabazonindians-nsn.gov

Gabrielino-Tongva Tribe

Charles Alvarez,
23454 Vanowen Street Gabrielino
West Hills, CA, 91307
Phone: (310) 403 - 6048
roadkingcharles@aol.com

Cahuilla Band of Indians

Daniel Salgado, Chairperson
52701 U.S. Highway 371 Cahuilla
Anza, CA, 92539
Phone: (951) 763 - 5549
Fax: (951) 763-2808
Chairman@cahuilla.net

Los Coyotes Band of Cahuilla and Cupeño Indians

Shane Chapparosa, Chairperson
P.O. Box 189 Cahuilla
Warner Springs, CA, 92086-0189
Phone: (760) 782 - 0711
Fax: (760) 782-0712

Gabrieleno Band of Mission Indians - Kizh Nation

Andrew Salas, Chairperson
P.O. Box 393 Gabrieleno
Covina, CA, 91723
Phone: (626) 926 - 4131
admin@gabrielenoindians.org

Morongo Band of Mission Indians

Robert Martin, Chairperson
12700 Pumarra Road Cahuilla
Banning, CA, 92220 Serrano
Phone: (951) 849 - 8807
Fax: (951) 922-8146
dtorres@morongo-nsn.gov

This list is current only as of the date of this document. Distribution of this list does not relieve any person of statutory responsibility as defined in Section 7050.5 of the Health and Safety Code, Section 5097.94 of the Public Resource Section 5097.98 of the Public Resources Code.

This list is only applicable for contacting local Native Americans with regard to cultural resources assessment for the proposed Proposed City Creek Channel Project – Victoria Avenue to Twin Creek Project, San Bernardino County.

**Native American Heritage Commission
Native American Contact List
San Bernardino County
10/29/2019**

**Morongo Band of Mission
Indians**

Denisa Torres, Cultural Resources
Manager
12700 Pumarra Rroad Cahuilla
Banning, CA, 92220 Serrano
Phone: (951) 849 - 8807
Fax: (951) 922-8146
dtorres@morongo-nsn.gov

Ramona Band of Cahuilla

Joseph Hamilton, Chairperson
P.O. Box 391670 Cahuilla
Anza, CA, 92539
Phone: (951) 763 - 4105
Fax: (951) 763-4325
admin@ramona-nsn.gov

Ramona Band of Cahuilla

John Gomez, Environmental
Coordinator
P. O. Box 391670 Cahuilla
Anza, CA, 92539
Phone: (951) 763 - 4105
Fax: (951) 763-4325
jgomez@ramona-nsn.gov

**San Fernando Band of Mission
Indians**

Donna Yocum, Chairperson
P.O. Box 221838 Kitanemuk
Newhall, CA, 91322 Vanyume
Phone: (503) 539 - 0933 Tataviam
Fax: (503) 574-3308
ddyocum@comcast.net

**San Manuel Band of Mission
Indians**

Lee Clauss, Director of Cultural
Resources
26569 Community Center Drive Serrano
Highland, CA, 92346
Phone: (909) 864 - 8933
Fax: (909) 864-3370
lclauss@sanmanuel-nsn.gov

**Santa Rosa Band of Cahuilla
Indians**

Mercedes Estrada,
P. O. Box 391820 Cahuilla
Anza, CA, 92539
Phone: (951) 659 - 2700
Fax: (951) 659-2228
mercedes.estrada@santarosacah
uilla-nsn.gov

**Santa Rosa Band of Cahuilla
Indians**

Steven Estrada, Chairperson
P.O. Box 391820 Cahuilla
Anza, CA, 92539
Phone: (951) 659 - 2700
Fax: (951) 659-2228
mflaxbeard@santarosacahuilla-
nsn.gov

**Serrano Nation of Mission
Indians**

Wayne Walker, Co-Chairperson
P. O. Box 343 Serrano
Patton, CA, 92369
Phone: (253) 370 - 0167
serranonation1@gmail.com

**Serrano Nation of Mission
Indians**

Mark Cochrane, Co-Chairperson
P. O. Box 343 Serrano
Patton, CA, 92369
Phone: (909) 528 - 9032
serranonation1@gmail.com

**Soboba Band of Luiseno
Indians**

Scott Cozart, Chairperson
P. O. Box 487 Cahuilla
San Jacinto, CA, 92583 Luiseno
Phone: (951) 654 - 2765
Fax: (951) 654-4198
jontiveros@soboba-nsn.gov

This list is current only as of the date of this document. Distribution of this list does not relieve any person of statutory responsibility as defined in Section 7050.5 of the Health and Safety Code, Section 5097.94 of the Public Resource Section 5097.98 of the Public Resources Code.

This list is only applicable for contacting local Native Americans with regard to cultural resources assessment for the proposed Proposed City Creek Channel Project – Victoria Avenue to Twin Creek Project, San Bernardino County.

Native American Heritage Commission
Native American Contact List
San Bernardino County
10/29/2019

**Soboba Band of Luiseno
Indians**

Joseph Ontiveros, Cultural
Resource Department
P.O. BOX 487 Cahuilla
San Jacinto, CA, 92581 Luiseno
Phone: (951) 663 - 5279
Fax: (951) 654-4198
jontiveros@soboba-nsn.gov

**Torres-Martinez Desert Cahuilla
Indians**

Michael Mirelez, Cultural
Resource Coordinator
P.O. Box 1160 Cahuilla
Thermal, CA, 92274
Phone: (760) 399 - 0022
Fax: (760) 397-8146
mmirelez@tmdci.org

This list is current only as of the date of this document. Distribution of this list does not relieve any person of statutory responsibility as defined in Section 7050.5 of the Health and Safety Code, Section 5097.94 of the Public Resource Section 5097.98 of the Public Resources Code.

This list is only applicable for contacting local Native Americans with regard to cultural resources assessment for the proposed Proposed City Creek Channel Project – Victoria Avenue to Twin Creek Project, San Bernardino County.

APPENDIX 3

**PREVIOUSLY IDENTIFIED CULTURAL RESOURCES
IN THE PROJECT AREA**

4/04

State of California - The Resources Agency
DEPARTMENT OF PARKS AND RECREATION
CONTINUATION SHEET

Primary #: P36-006848
HRI#/Trinomial: CA-SBR-6848H (UPDATE)

Page 1 of 3

*Resource Name or Number (Assigned by recorder): CA-SBR-6848H

*Recorded by: ECORP Consulting, Inc.

*Date: 3/9/2006

Continuation Update

This historic archaeological site, consisting of a segment of the Cram-Van Leuven Ditch, was originally recorded in 1993 during a cultural resources survey conducted by Gallegos and Associates. At that time, the ditch was found to be an unlined excavation with a central deeper area and shallower terraces on each side. It was measured at 30 feet wide and 10 feet deep, overall (Eighmey et al. 1993).

During a cultural resources survey conducted in March, 2006 by Ecorp Consulting, Inc. for a proposed residential development, this segment of the ditch was field checked and found to be consistent with the description of the original recorders. However, the ditch is irregular in width and depth, varying from approximately 75 feet wide and 10 feet deep at the eastern end of the segment, to 30 feet or less wide and 5 feet deep farther west. At its west end, the ditch terminates where it is interrupted by a modern concrete flood control channel that runs north-south. Approximately 1,115 feet west of this point, the ditch is completely filled with soil and no longer exists for a distance of approximately 840 feet, where it reemerges again as an open ditch and continues to the west. In the areas where it is still open, the ditch is strewn with boulders and overgrown with shrubs and grass.

References

Eighmey, Jim, Ivan Strudwick, Roxana Phillips, Petei McHenry, John Boughton, and Russell Collett
1993 Archaeological Site Record, Site CA-SBR-6848H, the Cram-Van Leuven Ditch. On file at the San Bernardino Archaeological Information Center, Redlands, California.

Mason, Roger D. and Cary D. Cotterman
2006 *Cultural Resources Survey Report for the Heather Glen Project, City of Highland, San Bernardino County, California.*
Prepared by ECORP Consulting, Santa Ana, California. Prepared for North American Residential Communities, San Dimas, California.



Cram-Van Leuven Ditch (CA-SBR-6848H), view toward west, 3/9/2006. Photo no. 27.

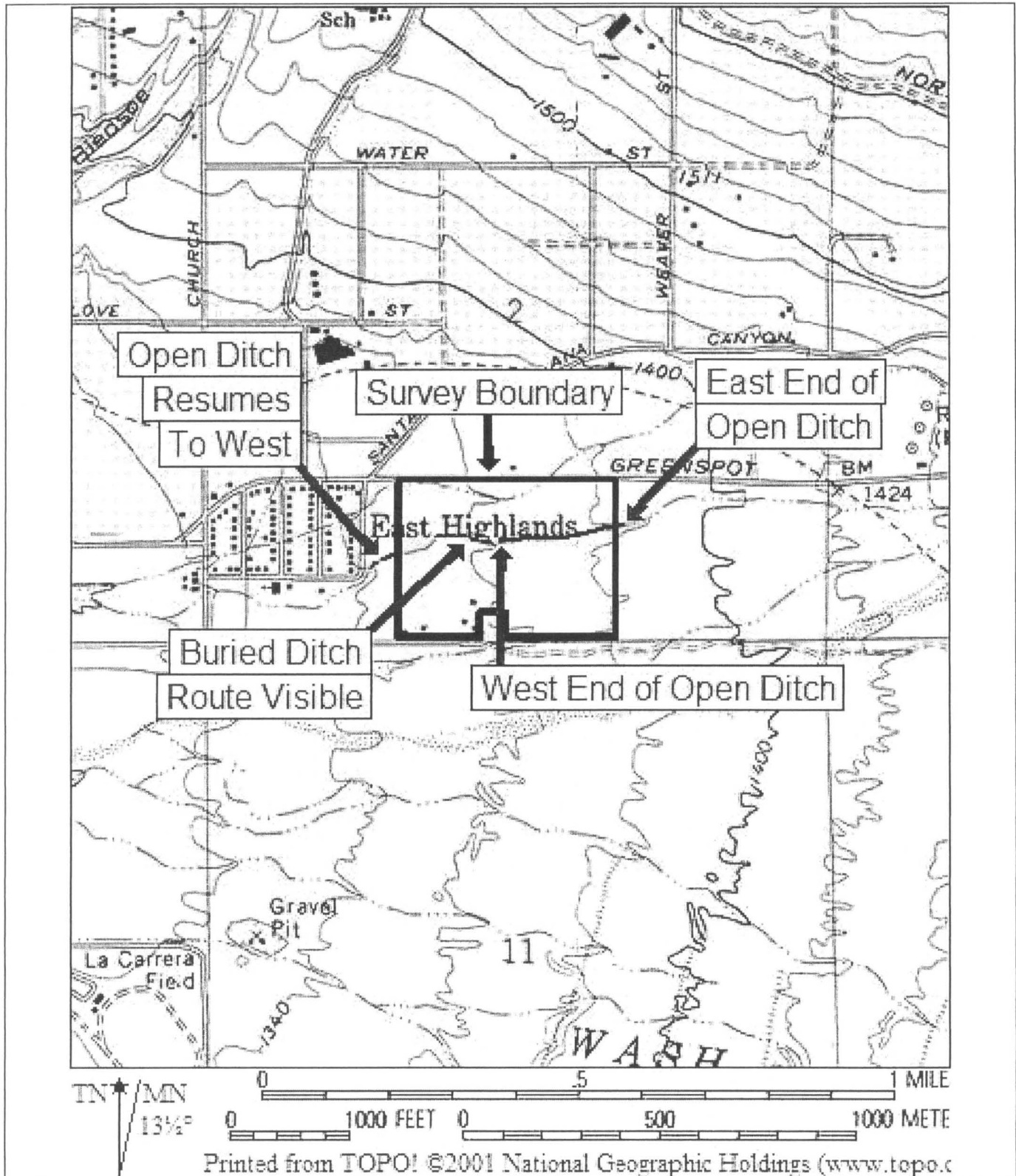

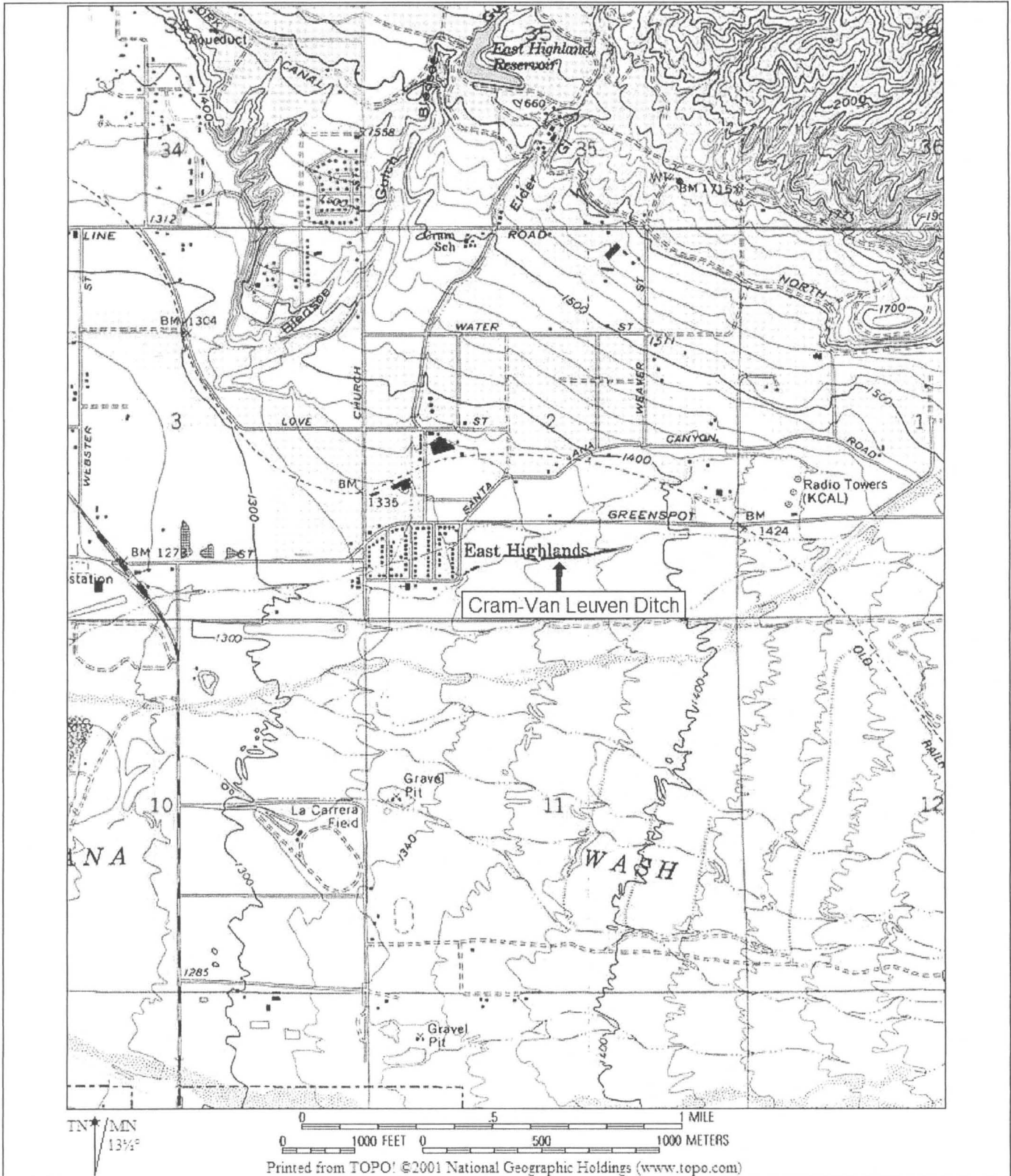

Concordia Homes - 114 ac.
Proj. 2-93

2552
WELLS

P2606848

2552 11 NW
(HARRISON MTN.)

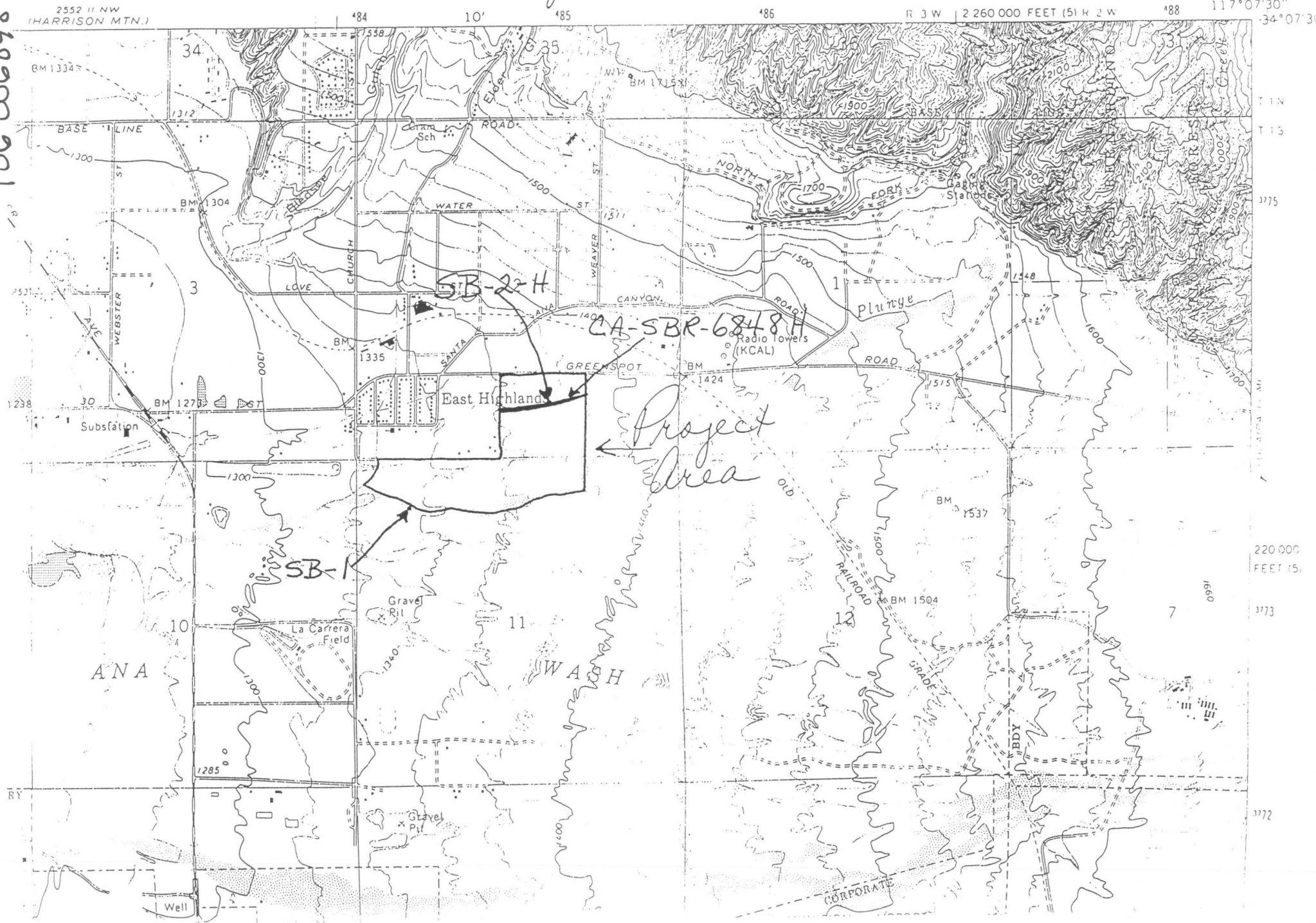

East Highlands

SB-22-H

CA-SBR-6848-H

Project Area

SB-1

La Carrera Field

W A H

CORPORATE

220 000
FEET (5)

P 36-006898

1063

State of California - The Resources Agency
DEPARTMENT OF PARKS AND RECREATION
ARCHAEOLOGICAL SITE RECORD

UPDATE

Permanent Trinomial: CA-SBR-6848H
Temporary Number: _____
Additional Designation: _____
Agency Designation: _____

Page 1 of 2

1. County: San Bernardino.
2. USGS Quad: Redlands (7.5') 1967 (15') _____ Photorevised 1988.
3. UTM Coordinates: Zone 11 / 485180 Easting / 3774040 Northing Eastern Boundary/
484720 / Easting / 3773940 Northing West Boundary ().
4. Township: 1S Range: 3W; SE of the SW to SW of the SE 1/4s of Section 2 .
Base (Mer) SB ().
5. Map Coordinates: 7.4 to 7.8 mm S, 34.5 to 32.5 mm E (from NW corner of map)
6. Elevation: 1360-1380 ft .
7. Location: Ditch is located approximately 200 feet south of Greenspot Road and exits approximately 600 feet south of Greenspot Road along 1700 feet of project area, and approximately four and one-half miles east of Highway 30 in the East Highlands area .
8. Prehistoric Historic XX Protohistoric .
9. Site Description: This irrigation ditch was originally excavated in 1858 and was named the Cram-Van Leuven Ditch after the two families responsible for providing the first irrigation waters to the East Highlands area. .
10. Area: 16-30 m (N/S width) x 518 m (E/W length) _____ m² .
Method of Determination: tape .
11. Depth: 1.3 to 3.1 m .
Method of Determination: tape .
12. Features: The ditch itself is the only feature.
13. Artifacts: N/A .
14. Non-Artifactual Constituents: N/A .
15. Date Updated: March 10, 1993 .
16. Updated By: Jim Eighmey, Ivan Strudwick, Roxana Phillips, Petei McHenry, John Boughton, and Russell Collett .
17. Affiliation and Address: Gallegos and Associates, 2227 Faraday, Suite C, Carlsbad, CA 92008 .
32. References: Cultural Resource Survey Report for the Concordia Homes Project, County of San Bernardino, California, Gallegos & Associates, March 1993.
33. Name of Project: Concordia Homes Cultural Resource Survey .
36. Photos: Yes Taken By: Petei McHenry .
37. Photo Accession Number: 2-93 On File At: Gallegos & Associates

PBG 006848

State of California - The Resources Agency
DEPARTMENT OF PARKS AND RECREATION

FEATURE RECORD

Permanent Trinomial: _____ / _____ mo. yr.

Temporary Number: CA - SBR - 6848 H

Page _____ of _____.

Agency Designation: _____

Type of Feature: Irrigation Ditch circa 1860's

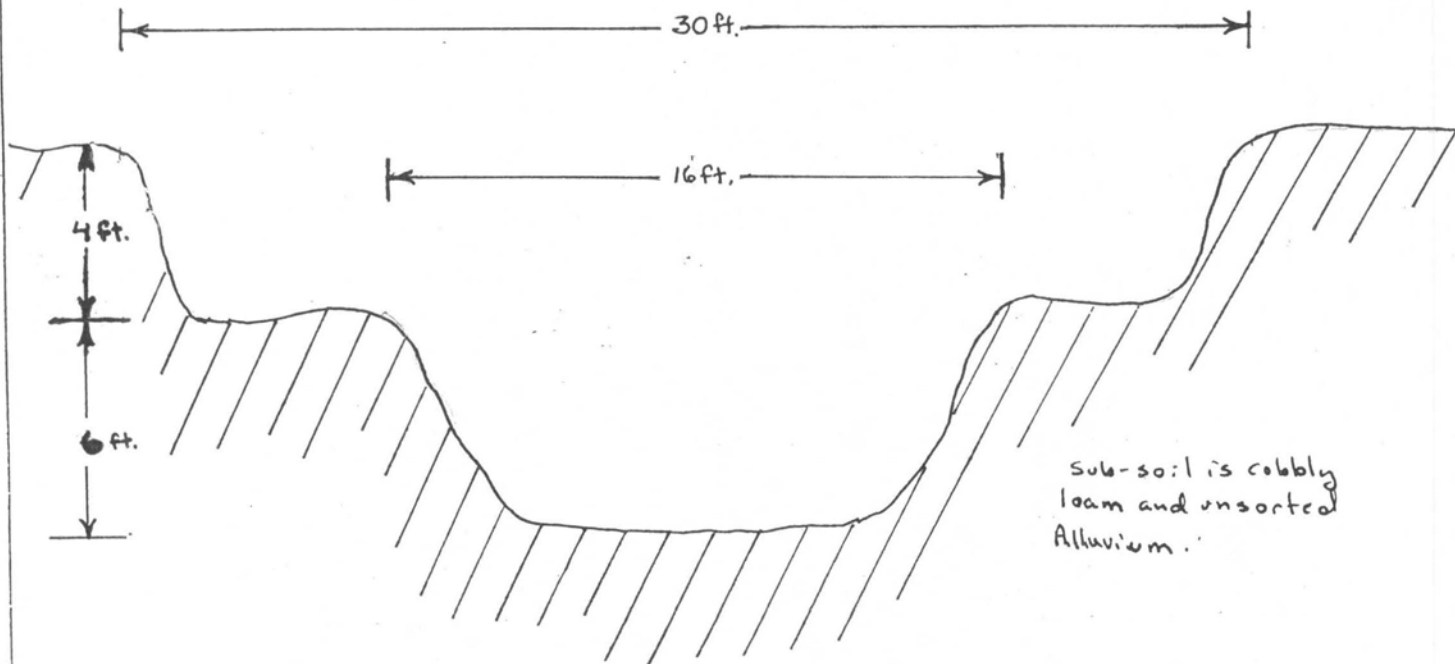

Cross-section of Cram-Vanheuver Ditch

Construction Notes: The ditch is unlined and somewhat irregular in cross-section. The path of the ditch is not linear, but appears to move irregularly from the North-east to the south-west across the project area. A series of trash dumps, some dating to the 1800's, are located nearby. No formal camps or dumps that can be directly tied to the construction of the ditch were noted. No dams or diversion structures were found within this section.

P36-006848

ARCHEOLOGICAL SITE RECORD

Temporary Number: _____

Page 1 of 3

Agency Designation: _____

1. County: San Bernardino

2. USGS Quad: Redlands (7.5') XXXXXX (15') TO EASTERN END Photorevised 1988

3. UTM Coordinates: Zone 11, 486120 Easting / 3774100 Northing ()

4. Township 1S Range 3W TO EASTERN END % of ----- % of N $\frac{1}{2}$ % of SW % of Section 1 Base (Mer) SBBM ()

5. Map Coordinates: 73 mmS 376 mmE (from NW corner of map) 6. Elevation 1424'

7. Location: This portion of the canal is located south of Greenspot Road, west of Plunge Creek and East of Weaver Street; identified on the USGS map as a blue line water course. ()

8. Prehistoric _____ Historic XXXXX Protohistoric _____ 9. Site Description: Irrigation Canal tentatively identified as the Cram & Van Leuven Ditch (ca. 1858), though there is a possibility that this designation is erroneous. Maps for the Cram and Van Leuven Ditch indicate that it was north of Greenspot Road in this area. ()

10. Area: 4m m(length)x ++ m(width) _____ m². Method of Determination: visual inspection ()

11. Depth: varies cm Method of Determination: visual inspection ()

12. Features: singel canal identified approximately 300 meters west of Plunge Creek (eastern extents destroyed) and consisting of a single elongated depression winding through the N $\frac{1}{2}$ of SW $\frac{1}{4}$ (Section 1) ()

13. Artifacts: modern materials impacting eastern portion of feature; other materials possibly buried. ()

14. Non-Artifactual Constituents: N.A. ()

15. Date Recorded: May 29, 1992 16. Recorded By: Jeanette A. McKenna ()

17. Affiliation and Address: McKenna et al., Whittier CA 90601 (310) 696-3852 ()

P86-006848

STATE OF CALIFORNIA - DEPARTMENT OF TRANSPORTATION
ARCHEOLOGICAL SITE RECORD
DPD-OEA-003B (01/90)

Permanent Trinomial: CA-SBR-6848H / June 1992
mo yr

Temporary Number: _____

Page 2 of 3

Agency Designation: _____

18. Human Remains: none observed _____ ()

19. Site Integrity: portions impacted; portions destroyed; portions intact _____ ()

20. Nearest Water (type, distance and direction): Plunge Creek immediately to east _____ ()

21. Largest Body of Water within 1 km (type, distance and direction): N.A. _____ ()

22. Vegetation Community (site vicinity): coastal scrub {Plant List()} _____ ()

23. Vegetation Community (on site): coastal scrub w/some intrusive trees {Plant List()} _____ ()

References for above: Munz 1977 _____ ()

24. Site Soil: sany loam/cobbles () 25. Surrounding Soil: sany loam/cobbles _____ ()

26. Geology: foothills () 27. Landform: drainage floodplain _____ ()

28. Slope: slight to southwest () 29. Exposure: open _____ ()

30. Landowner(s) (and/or tenants) and Address: unknown _____ ()

31. Remarks: Site was described by Greenwood & Associates as C & VL Ditch,
but may be a privately developed ditch ... additional research
recommended. _____ ()

32. References: McKenna 1992 _____ ()

33. Name of Project: Greenspot Road Pipeline Project (Water District) _____ ()

34. Type of Investigation: Phase I survey and archaeological monitoring program _____ ()

35. Site Accession Number: N.A. Curated At: N.A. _____ ()

36. Photos: on file, McKenna et al. Taken By: Jeanette A. McKenna _____ ()

37. Photo Accession Number: N.A. On File At: McKenna et al., Whittier CA _____ ()

P36-606848

State of California - The Resources Agency
DEPARTMENT OF PARKS AND RECREATION

Permanent Trinomial: CA-SBR-6848H / June 1992

mo. yr.

ARCHEOLOGICAL SITE LOCATION
MAP

Temporary Number: _____

Page 3 of 3

Agency Designation: _____

REDLAN

7.5 MINUTE

SW/4 R

486

R 3 W | 2 260 000

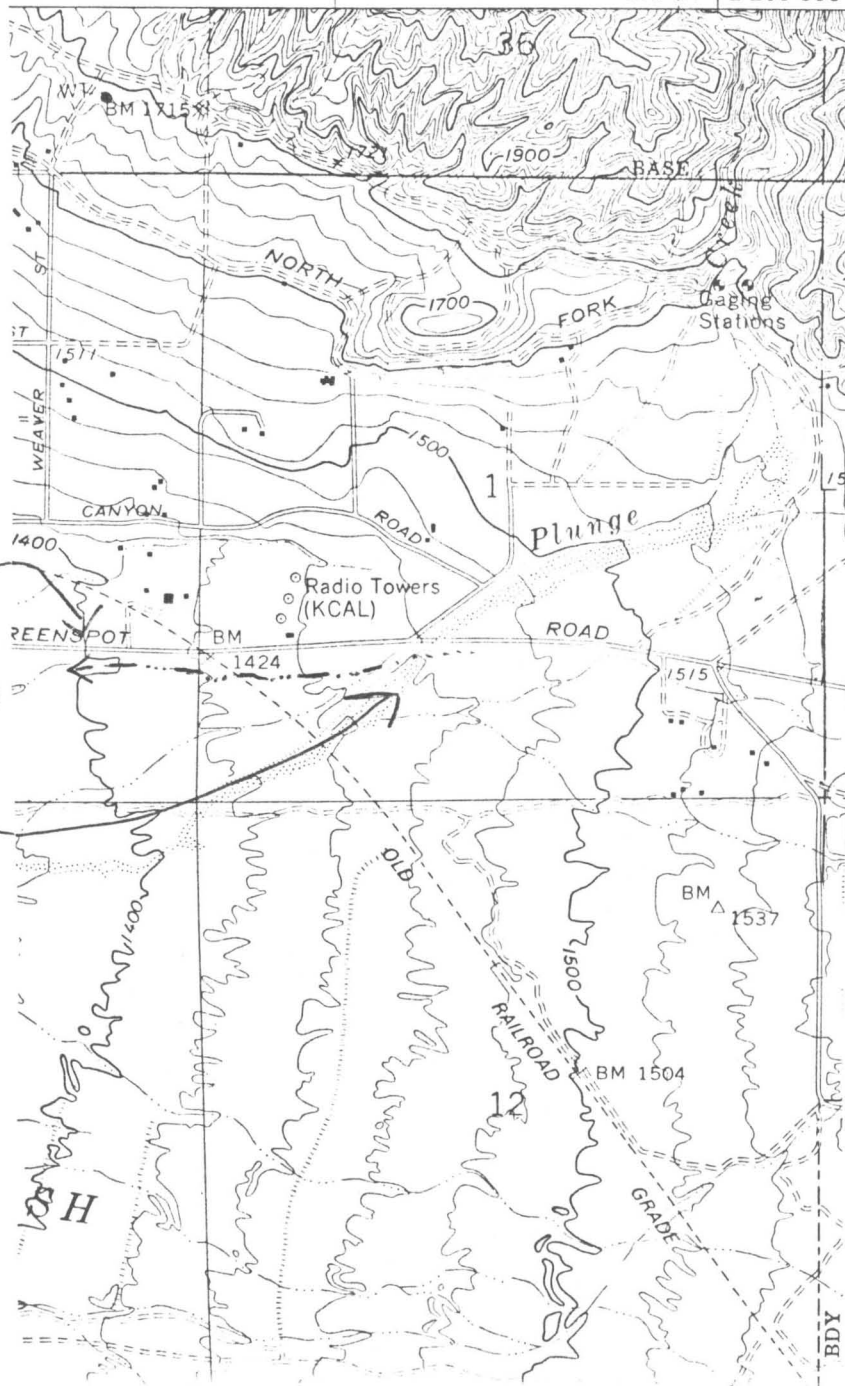

CANAL LIKELY
CONTINUES TO
WEST. EASTERN
PORTIONS DISTURBED
OR DESTROYED

ARCHAEOLOGICAL SITE RECORD

PAGE: 1 OF 7
DATE OF ORIGINAL RECORD: N/A
DATE OF THIS FORM: 12/17/90
PERMANENT TRINOMIAL: CA-SBR-6848H
TEMPORARY NUMBER: R-FEH #2
AGENCY DESIGNATION: PSBR-20H

1. COUNTY: San Bernardino
2. USGS QUAD: Redlands 7.5' 1967 REVISED: 1988
3. UTM COORDINATES: ZONE 11 483880 m Easting; 3773980 m Northing
4. TOWNSHIP 1S RANGE 3W, - , - , SE 1/4, SE 1/4, of Section 3
BASE MER. SBM
5. MAP COORDINATES: 77 mm S 287 mm E
6. ELEVATION: 1300 ft.

7. LOCATION: From Interstate 10 in Redlands, take the Orange Street exit north for 3 miles, turn right on 5th Street and continue for 0.4 mile. Site begins across from the east end of the Village Lakes housing tract, approximately 5 miles south of 5th Street and continues east to Church Street.

8. PREHISTORIC HISTORIC X PROTOHISTORIC

9. SITE DESCRIPTION: Plotted location of Cram and Van Leuven Ditch (ca. 1858). Irrigation complex with associated earthen ditches. Site contains an east/west feeder flume, two north/south earthen canals, one north/south concrete canal, a weir, a portion of a concrete covered flume, and a portion of a southwest/northeast earthen ditch (PSBR-20H).

10. AREA: 600 m (length) x m (width); m²
Method: Odometer and tape.

11. DEPTH: METHOD: N/A

12. FEATURES: #1) An east/west linear, 0.3 mile long, U-shaped feeder flume on the south side of 5th Street. #1A) From the western north/south canal and extending approximately 40 meters (X)

13. ARTIFACTS: Six sun-colored amethyst glass fragments.

14. NON-ARTIFACTUAL CONSTITUENTS: Pepper trees to the south and east. Citrus orchard to the north.

15. DATE OF ORIGINAL RECORD: N/A DATE OF THIS FORM: 12/17/90

16. RECORDED BY: Gwendolyn Romani, Genevieve Head, Neal Kaptain, and Tricia Webb.

17. AFFILIATION: Greenwood and Associates, 725 Jacon Way,
725 Jacon Way, Pacific Palisades, CA 90272
(213) 454-3091

P36006848

ARCHAEOLOGICAL SITE RECORD

PAGE: 2 OF 7

DATE OF ORIGINAL RECORD: N/A

PERMANENT TRINOMIAL: SBR-6348H

TEMPORARY NUMBER: R-FEH #2
and PSBR-20H

DATE OF THIS FORM: 12/17/90

AGENCY DESIGNATION:

18. HUMAN REMAINS: None observed.

19. SITE INTEGRITY: Flume is largely intact, but filled in. Most of PSBR-20H has been destroyed. Other sections active as needed.

20. NEAREST WATER: Santa Ana River approximately 500 m. south.

21. VEGETATION COMMUNITY (SITE VICINITY): Citrus orchard to north.

22. VEGETATION COMMUNITY (ON SITE): Ruderal (old orchard removed).

REFERENCES FOR ABOVE: N/A

23. SITE SOIL: Sand and gravel loam.

24. SURROUNDING SOIL: Same as 23

25. GEOLOGY: Granitic.

26. LANDFORM: River terrace.

27. SLOPE: 0

28. EXPOSURE: Open.

29. LANDOWNERS(S), (TENANTS), ADDRESS: East Highland Ranch (lot is a future commercial building site).

30. REMARKS: There is a 1950-60's dump containing household materials, furniture, pipes, etc. south of site near west and south end of Church Street.

32. REFERENCES:-

33. NAME OF PROJECT: Metropolitan Water District Inland Feeder Cultural Resource Investigation.

34. TYPE OF INVESTIGATION: Preliminary surface reconnaissance

35. SITE ACCESSION NO.:

CURATED AT:

36. PHOTOS: Overviews, B & W prints.

TAKEN BY: Gwen Romani
and Neal Kaptain.

37. PHOTO ACCESSION NO. N/A ON FILE AT: Greenwood and Associates

P36-006848

ARCHAEOLOGICAL SITE LOCATION MAP

PAGE: 3 OF 7

DATE OF ORIGINAL RECORD:

DATE OF THIS FORM: 12/17/90

U.S.G.S. 7.5' QUADRANGLE: Redlands

PERMANENT TRINOMIAL: SBR-6848H

TEMPORARY NUMBER: R-FEH #2
and PSBR-20H

AGENCY DESIGNATION:

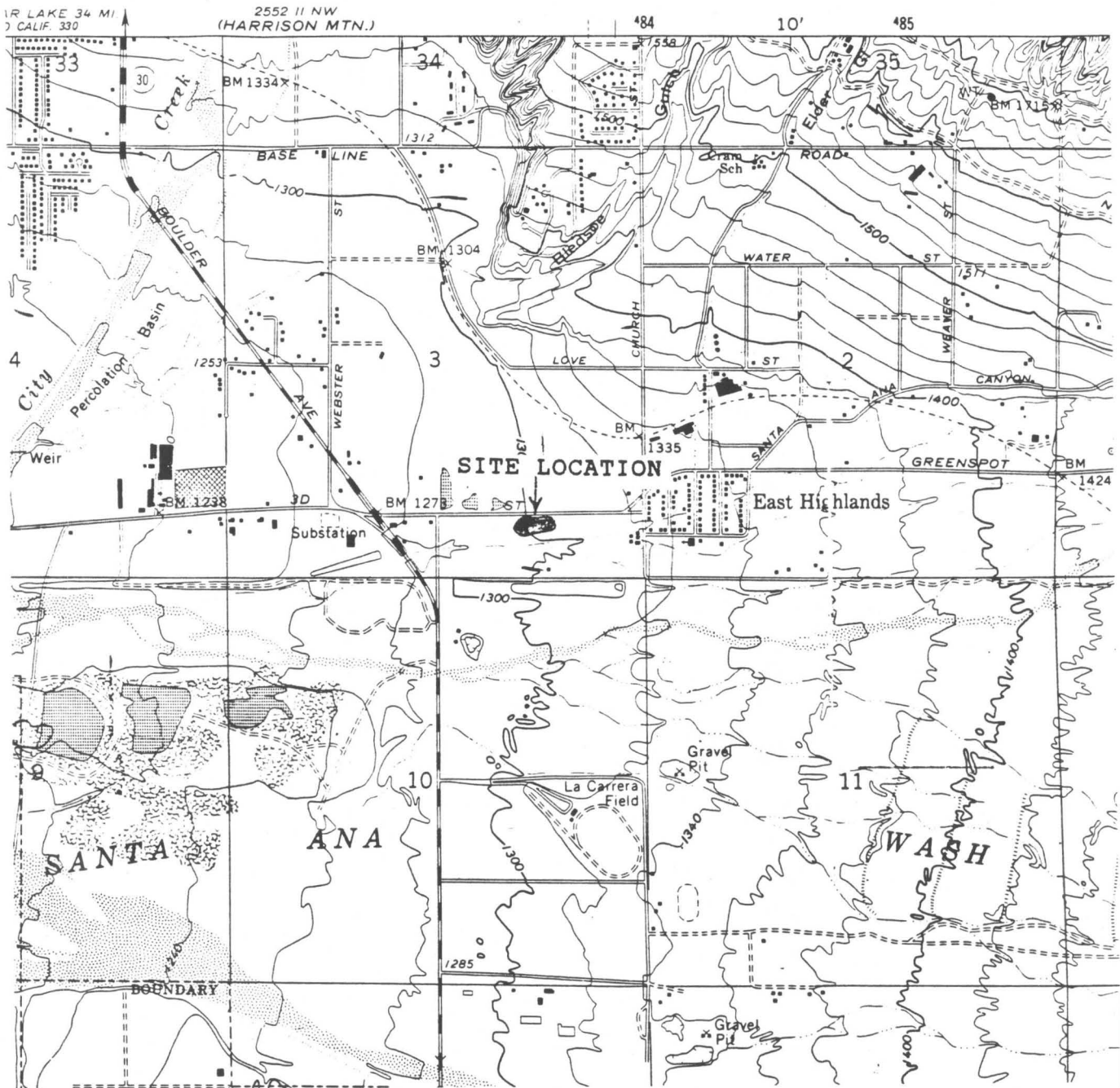

ARCHEOLOGICAL SITE
MAP

Permanent Trinomial: SR-6848H / _____ mo. yr.

Temporary Number: Redlands FEH #2

Agency Designation: _____

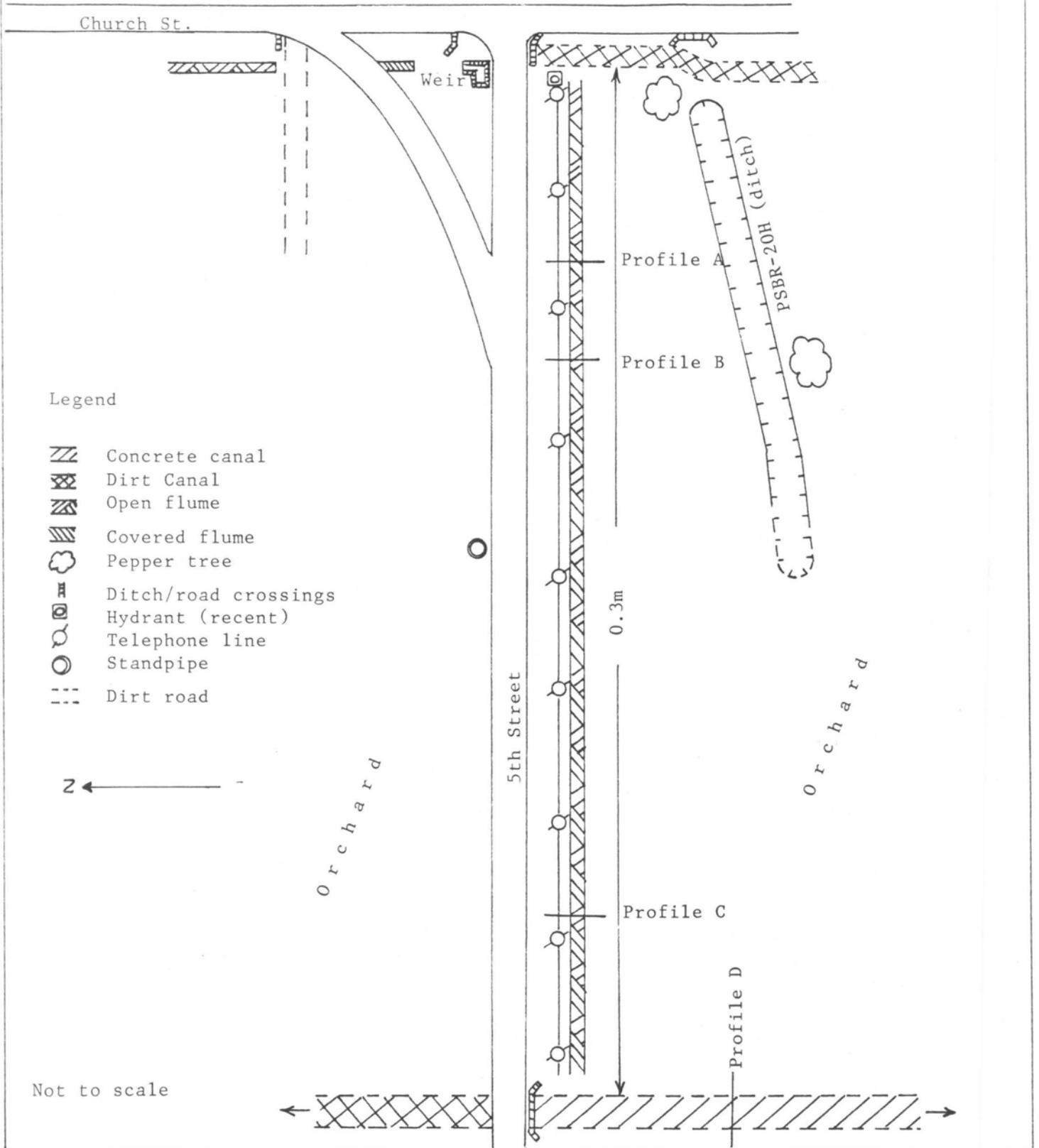

Legend

- Concrete canal
- Dirt Canal
- Open flume
- Covered flume
- Pepper tree
- Ditch/road crossings
- Hydrant (recent)
- Telephone line
- Standpipe
- Dirt road



Not to scale

State of California - The Resources Agency
DEPARTMENT OF PARKS AND RECREATION
ARCHEOLOGICAL SITE
MAP

Permanent Trinomial: S3C-6848H 1 _____
mo. yr.

Temporary Number: Redlands FEH - #2

Page 5 of 7

Agency Designation: _____

Profile A
Looking east

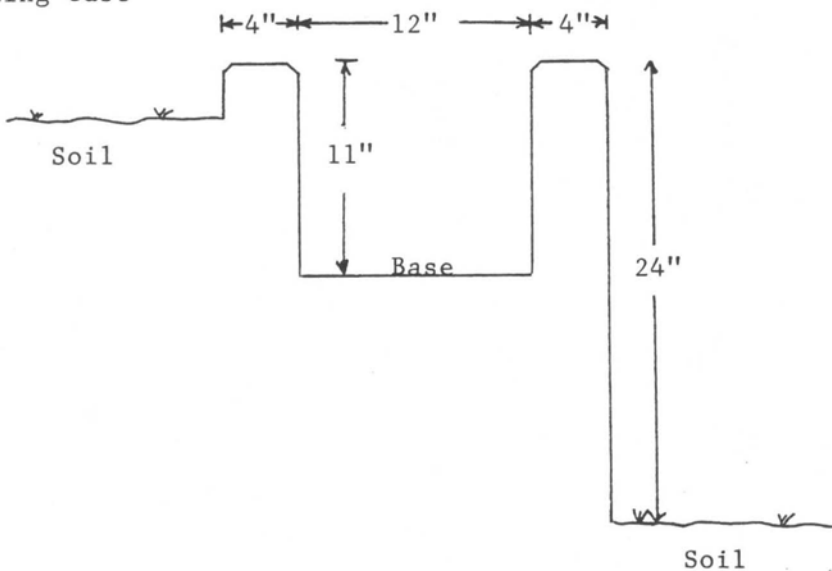

Poured concrete flume,
used to irrigate
adjacent field to the south.
South wall has small metal gates
every meter for water diversion.
Westernmost 40m is constructed
of mortared granite blocks.

Profile B
Looking east

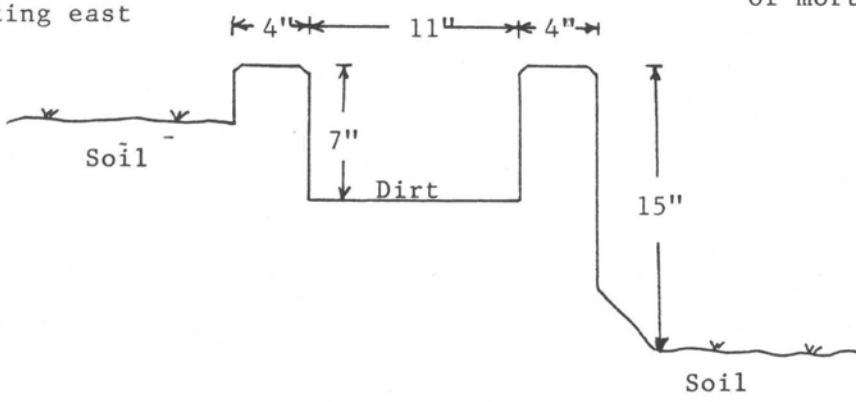

P36-006848

State of California - The Resources Agency
DEPARTMENT OF PARKS AND RECREATION
ARCHEOLOGICAL SITE
MAP

Permanent Trinomial: SCR-6848H / _____ mo. _____ yr.

Temporary Number: Redlands - FEH - #2

Page 6 of 7.

Agency Designation: _____

Profile C
Looking East

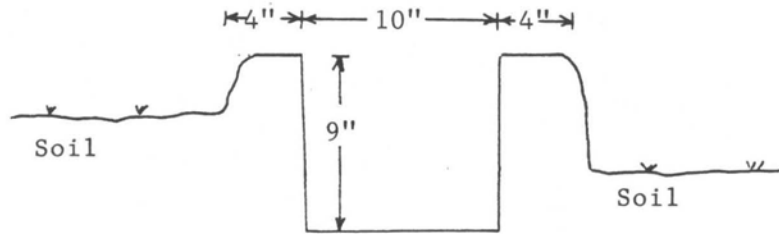

Flume made of mortared granite stones with metal irrigation gates every 5'.

Profile D
Looking East

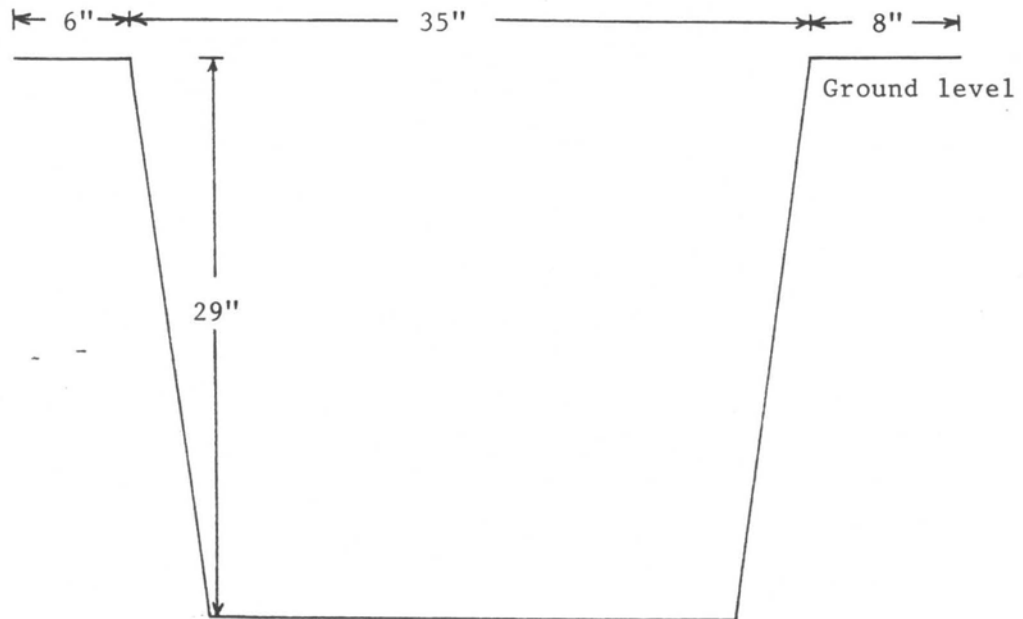

P36-00684/8

ARCHAEOLOGICAL SITE RECORD - CONTINUATION

PAGE: 7 OF 7

PERMANENT TRINOMIAL: SBR-6848H

DATE OF ORIGINAL RECORD:

TEMPORARY NUMBER: R-FEH #2
and PSBR-20H

DATE OF THIS FORM: 12/17/90

AGENCY DESIGNATION:

CONTINUATION

ITEM NO.

(12.) east, the flume is a split cobble with concrete base feeder flume (interior 10" wide), with south facing metal gates every 1.5 meters (see Profile C). #1B) is the remaining eastern portion of the flume which is constructed of poured concrete (interior 11-12") with south facing flow regulator gates at 1 meter intervals (see Profiles A & B). Most of the flume has been filled in by dirt and adjacent outside soil levels are high. The east and west end have either been covered by dirt or destroyed.

#2) Approximately 30 meters west of flume is a small (top interior 35") north/south concrete canal that extends from 5th Street south for approximately 100 meters (see Profile D).

#3) North of Canal #2 is a concrete culvert that passes under 5th Street and continues into a 3-4' wide x 1-2' deep earthen ditch that continues north for approximately 1/4 mile and drains the existing easterly citrus orchard to the south.

#4) A portion of PSBR-20H (Cram and Van Leuven Ditch - ca. 1858). It has been partially filled in and destroyed to the west and east by either the orchard or removal of the orchard (south of flume in vacant lot).

#5) At eastern end of flume is a somewhat V-shaped dirt canal (approximately 3' deep and 7' across at top) that runs north/south with a dogleg along the west side of and to the end of Church Street.

#6) North of #5 on an island between 5th Street and Church Street are two concrete weirs (one fenced, the other covered by grating).

#7) North of the weir is a covered flume that continues under 5th Street to #8.

#8) An open flume west of Church Street.

#9) A two lobed concrete standpipe north of 5th Street.



FIGURE 5.--Ditch built by Bishop Nathan C. Tenney in 1856; used as part of the Berry Roberts ditch in 1868.

Still another irrigation development in the general area took place at about this time. Lewis F. Cram and his brothers and Frederick Van Leuven and his sons, who had irrigated land serviced by the Mill Creek zanja within the Mormon-owned San Bernardino Rancho, acquired land lying near East Highlands, east of City Creek Wash. In 1858 they built an irrigation ditch from the Santa Ana River to their newly acquired land (Beattie, 1951, p. 3). The head of the ditch was at the mouth of the canyon, upstream from the original headworks of the North Fork and Timber ditches, and the ditch itself extended to City Creek, as shown in figure 6. This new diversion reduced the river flow at the headworks of the North Fork and Timber ditches, and at times there was insufficient water carried in those ditches to satisfy requirements.

That situation continued until August 1860, when a suit was filed against owners of the Cram and Van Leuven ditch by the majority of the Timber ditch owners (Beattie, 1951, p. 4). The suit did not go to trial but was settled by a compromise court judgment on June 18, 1861. That judgment gave owners of the Cram and Van Leuven ditch a right to one-sixth of the river flow at the mouth of the canyon (Hall, 1888, p. 147). It was the first water right in the Santa Ana River basin to be adjudicated by a court.

The next event of significance with respect to water development in the San Bernardino Valley was the calamitous flood of 1862. That flood had a major effect on the channel of the Santa Ana River. Prior to the flood the river, upstream from what is now Redlands, was a narrow meandering stream lined with alder, willow, sycamore, and cottonwood trees (Beattie, 1951, p. 5). The flood washed out the trees and deposited sand, gravel, and

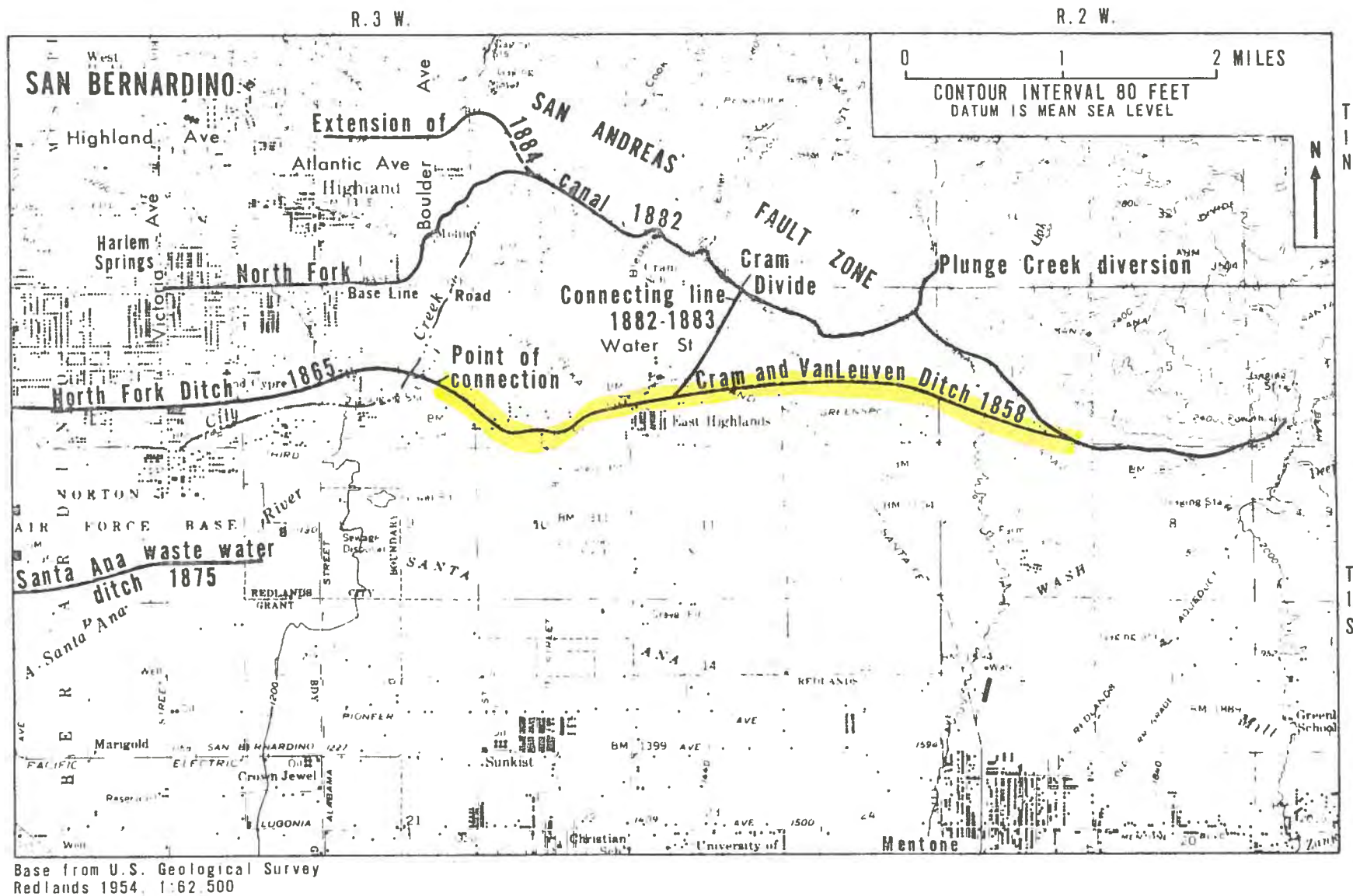

FIGURE 6.--Cram and Van Leuven ditch and North Fork Canal.

PSG-006898

boulders on the riverbed and on the adjacent inundated area. After the flood the river no longer followed a well-defined course, but instead ran in several channels below the mouth of the canyon, upstream from the common point of diversion for the North Fork and Timber ditches. The seepage loss through the beds of the new channels was sufficiently great to create a serious water deficiency at the heading of the ditches. Because of this condition the North Fork ditch was extended, as will be explained shortly, to a new heading nearer the mouth of the canyon. The location of the Timber ditch heading remained unchanged.

With regard to the acreage irrigated by the North Fork and Timber ditches, no official records were kept until 1864, when the newly created and elected San Bernardino County Water Commissioners recorded water rights, applications for ditch construction, and irrigated acreage. However, Hall (1888, p. 45) noted that water from the Timber ditch irrigated 50 acres in 1857. Records of the water commissioners showed that irrigated acreage in the Timber Settlement had increased to 242 acres by 1864, and to 369 acres by 1872 (Beattie, 1951, p. 2). The acreage irrigated in 1872 was probably the maximum acreage ever serviced by the Timber ditch, because after 1872 a gradual transfer of Timber ditch water rights to other localities occurred. No comparative figures for the North Fork ditch were recorded.

It was mentioned earlier that the owners of North Fork ditch had decided, after the flood of 1862, to extend their ditch upstream to a new heading at the mouth of the canyon. Furthermore, they realized that the cheapest way to accomplish that change would be through use of the existing Cram and Van Leuven ditch, which headed at the mouth of the canyon. Accordingly, in 1865, they requested permission of the owners of the Cram and Van Leuven ditch to make use of that ditch for transporting North Fork water to a connection to be built between the North Fork and Cram and Van Leuven ditches. In return the owners of the North Fork ditch offered to enlarge the Cram and Van Leuven ditch and share operating expenses. The Cram and Van Leuven ditch owners granted the request because of the advantage of having a larger volume of water flowing in the ditch. The ditch was enlarged, the connection to North Fork ditch shown in figure 6 was completed, and from that time on North Fork and Cram and Van Leuven water has been diverted through a common facility at the mouth of the canyon. As a result of this development, the Cram and Van Leuven ditch upstream from the connection with North Fork ditch, also became known as North Fork ditch.

Although the adjudication of 1861 (p. 14) gave the Cram and Van Leuven ditch owners a right to one-sixth of the water of the Santa Ana River at the mouth of the canyon, the respective rights of water diverted by the owners of the Timber and North Fork ditches were never formally established. Testimony in that litigation indicated an informal recognition that the Timber ditch was entitled to two-thirds and the North Fork ditch to one-third, of the remaining five-sixths of the water in the river. This division of flow between the Timber and North Fork ditches, in the ratio of 2:1, was approved by the water commissioners, and they issued an order to that effect on May 29, 1872 (Beattie, 1951, p. 4).

The owners of the North Fork ditch were dissatisfied with the commission's order; they claimed that the combined entitlement of the North Fork and Timber ditches should be divided equally between the two ditches. Furthermore, they were interested in maintaining their rights to use of the water, whereas the owners of Timber ditch were gradually selling their water rights to landowners on the south side of the Santa Ana River. The North Fork ditch owners pressed their case and on June 12, 1879, the two groups agreed to an equal division of water between the two ditches (Beattie, 1951, p. 4). That agreement was approved by the water commissioners. By this time, however, all Timber ditch water rights had been transferred to the Berry Roberts ditch (p. 22-25) and the Timber ditch was abandoned--probably about 1878 (Hall, 1888, p. 162-163).

With each passing year additional agricultural development took place in the San Bernardino Valley. In 1880 R. J. Cunningham, representing a number of Riverside investors, purchased a considerable acreage and North Fork water rights along City Creek, south of Harlem Springs (Beattie, 1951, p. 19). John Stone, one of Cunningham's clients, purchased rights to 43 hours of North Fork water through Cunningham and became the principal owner of the North Fork ditch. The land between Base Line Road and City Creek was planted to deciduous fruits and other crops, and by the second year most of the land was under cultivation.

A year earlier, in 1879, E. G. Judson and Frank E. Brown had become interested in the potential of the benchland above the Cram and Van Leuven and North Fork ditches for raising oranges, a crop with more value than the vegetables grown on the lowland (Beattie, 1951, p. 16). They purchased the claims of settlers living near Plunge Creek in sec. 35, T. 1 N., R. 3 W., and secured options on other parcels of land in the vicinity of sec. 35. To bring water to the benchland, Judson and Brown met several times with owners of the two ditches and offered to build a new high-line ditch for \$1,000. The North Fork ditch owners opposed the plan, but by 1880, several owners of land on the bench had purchased lowland water rights and requested transfer of those rights to the benchland (Hall, 1888, p. 148). Judson and Brown and the owners of North Fork ditch rights signed an agreement, in the spring of 1881, for the construction of a high-line ditch to serve the benchlands.

North Fork Canal

Construction of the high-line ditch, known as the North Fork Canal, began in the autumn of 1881, and it was completed and in operation in April of the following year (Hall, 1888, p. 148). The North Fork Canal left the original Cram and Van Leuven ditch a short distance west of the east line of sec. 6, T. 1 S., R. 2 W., and followed the course shown in figure 6 to City Creek. To reach the area along Base Line Road, the canal crossed City Creek in a flume, then turned south, probably following along the route of the old City Creek-Base Line ditch of 1865. This route followed along Boulder Avenue to Base Line Road, then west to Victoria Avenue, as described later in the section of this report titled, "City Creek Water Company" (p. 107). Part of this route may be that followed by the present-day Snake ditch (fig. 41) that is

2:

**IRRIGATION SYSTEMS FOR AGRICULTURAL LAND ON THE
NORTH SIDE OF THE SANTA ANA RIVER**Cram and Van Leuven Ditch (1858)

The earliest of the irrigation systems emerging from Santa Ana Canyon was the Cram and Van Leuven Ditch. Prior to the digging of this ditch by Lewis Cram and his brothers and Frederick Van Leuven and his sons, all other ditches had their intake in the Santa Ana River, well below the mouth of the Upper Santa Ana River, outside the scope of this study (Figure 1). This was the first ditch to begin at the Santa Ana Canyon mouth, thereby reducing water lost across the alluvial fan due to percolation and evaporation. The ditch led from the canyon to Cram and Van Leuven lands at the base of East Highlands Mesa and continued west to City Creek wash in San Bernardino (Beattie 1951:3). Conflicts over water rights developed in August 1860 with a lawsuit being filed by Timber and North Fork Ditch owners (irrigation ditches located eight miles below Upper Santa Ana Canyon mouth). The case was settled in 1861 with the recognition of the right of Cram and Van Leuven to one-sixth of the flow of the river at the canyon mouth. This decision represented the first water rights dispute in the Upper Santa Ana River to be adjudicated by the courts (Beattie 1951:4).

The flood of 1862 reworked the river channel to such an extent that both downstream ditches, especially North Fork, were left largely useless. In 1865, the North Fork shareholders petitioned the owners of the Cram and Van Leuven ditch for permission to enlarge the Cram and Van Leuven ditch to carry the North Fork water (Beattie 1951:6). Consent was given for this arrangement as it was distinctly advantageous to both groups. The North Fork users would lose less water through riverbed seepage and Cram and Van Leuven water right holders would gain from the greater water flow through the joint canal. The ditch was enlarged and lengthened to reach North Fork lands. Nothing of the ditch remains today.

North Fork Ditch (1885-Present): SAC-33

By the early 1880s, water shareholders in the Cram and Van Leuven and North Fork ditches were limited to irrigating relatively low quality land on the edge of the Santa Ana River. The construction of a new canal at a higher elevation (highline) along the rugged base of the San Bernardino Mountains would maximize the potential acres which could receive irrigation water. A new canal would allow water to be carried onto the "benchlands" or mesas where oranges, a high value crop, could be grown. The North Fork Ditch represents the capital-intensive projects which were undertaken during the real estate boom of the 1880s.

aboriginal society had been disrupted by missionization and the resultant changes in land tenure to such an extent that it never really returned to its former state. Following a period of Mexican cattle ranches in the 1840's and the development of the valley by the Mormons in the 1850's, the beginnings of American agricultural development came, including the citrus industry and the development of irrigation systems, two areas of historical interest which are directly tied to the cultural resources of the East Highland Ranch area.

P1063-5-H
The first irrigation ditch to be built through the study area was known as the Cram-Van Leuven Ditch, since it was built by members of those two pioneer families to bring water to their lands from the Santa Ana River. This ditch was first dug in 1858, and ran from the mouth of the Santa Ana Canyon to their lands at the base of what is today known as the East Highlands bench (Beattie 1951:3). The Cram-Van Leuven Ditch crossed the southwestern portion of the project site, following a route south of the Santa Ana Canyon Road and passing through the present townsite of East Highlands before ending east of the City Creek Wash, approximately on what is now East Third Street.

There had earlier, in 1856, been a ditch called the North Fork Ditch which was downstream 8 miles from the Cram-Van Leuven Ditch, and which directed water from the river to a community called the City Creek Settlement, since it was located on the bank of City Creek, approximately on today's Sixth Street between Waterman and Sterling Avenues. When the river flooded in 1862, it ruined the intake of that ditch and so the people of the City Creek Settlement asked the Crams and Van Leuven for permission to enlarge their ditch and extend it to serve City Creek area (Beattie 1951:6, Wright 1981).

In 1879, Redlands developers Judson and Brown became interested in the

Figure 1
 Historical Development of
 SANTA ANA CANYON IRRIGATION PROJECTS
 San Bernardino County, California

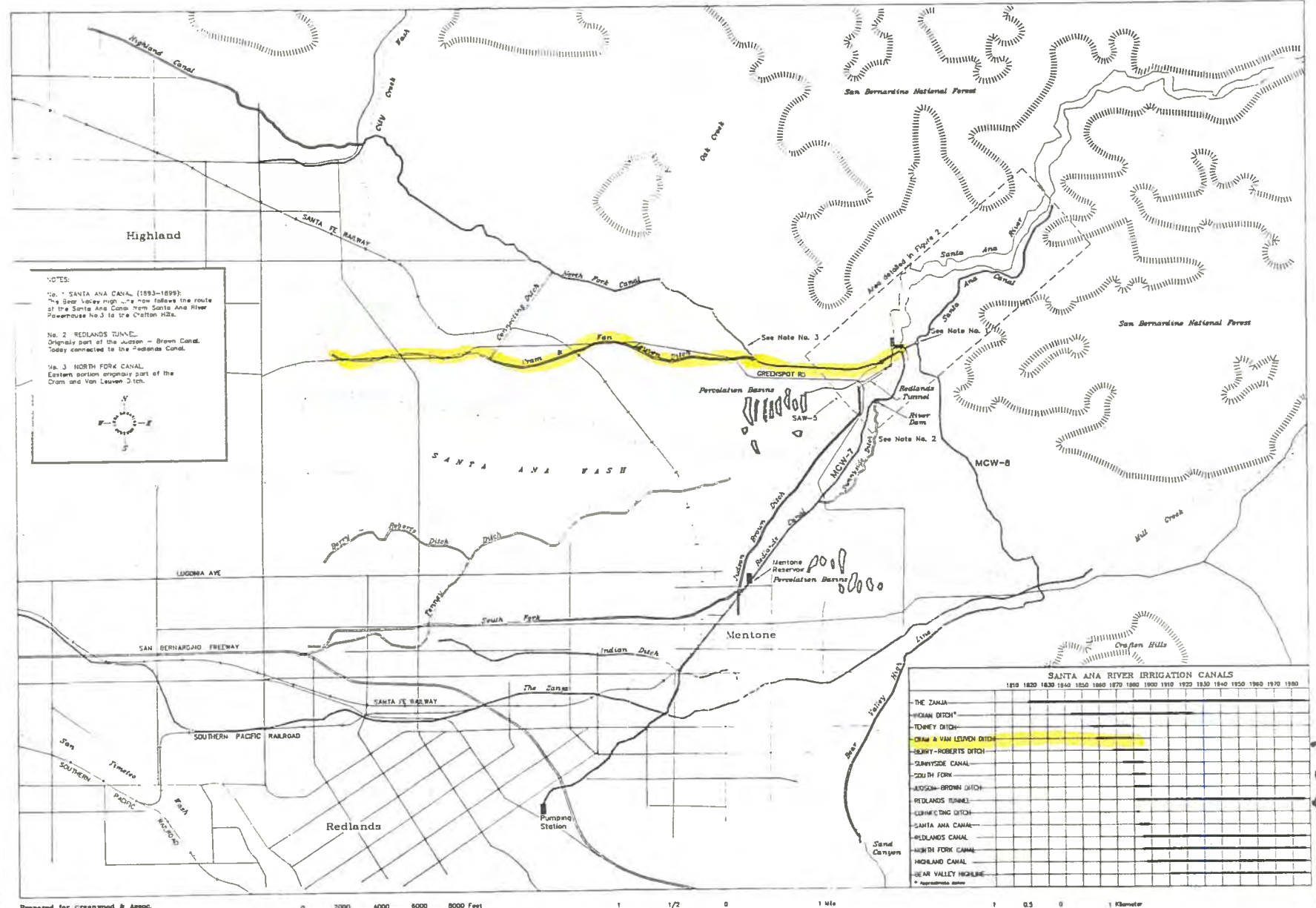

NOTES:
 No. 1 SANTA ANA CANAL (1893-1899):
 The Bear Valley High Line now follows the route of the Santa Ana Canal from Santa Ana River Reservoir No. 3 to the Cotton Hill.
 No. 2 REDLANDS TUNNEL:
 Originally part of the aucton - Brown Canal. Today connected to the Redlands Canal.
 No. 3 NORTH FORK CANAL:
 Eastern portion originally part of the Drom and Van Leuven Ditch.



SANTA ANA RIVER IRRIGATION CANALS

	1810	1820	1830	1840	1850	1860	1870	1880	1890	1900	1910	1920	1930
THE CANALS													
HOAN DITCH													
TOWNEY DITCH													
DRAW & VAN LEUVEN DITCH													
BEHRY-ROBERTS DITCH													
BERNYSDE CANAL													
SOUTH FORK													
ATOSON-BROWN DITCH													
REDLANDS TUNNEL													
CLINE DING DITCH													
SANTA ANA CANAL													
REDLANDS CANAL													
NORTH FORK CANAL													
HIGHLAND CANAL													
BEAR VALLEY HIGHLINE													
* Approximate dates													

Prepared for Greenwood & Assoc.
 by Area Location Systems
 Northridge, California
 (818) 993-4275 87-04 12/87

0 2000 4000 6000 8000 Feet

1 1/2 0 1 Mile

1 0.5 0 1 Kilometer

Report 88-
 PSC-006848
 PSCA-1004

State of California--The Resources Agency
DEPARTMENT OF PARKS AND RECREATION
CONTINUATION SHEET

Primary # 36-033079 (Update)

HRI #

Trinomial

Page 1 of 3

Resource name or # (Assigned by recorder)

Recorded by Daniel Ballester

Date December 10, 2019

Continuation Update

Form Prepared by Bai "Tom" Tang

Date January 29, 2019

Affiliation: CRM TECH, Colton

Project No: CRM TECH 3553

On December 10, 2019, a systematic archaeological field survey was conducted on the entire length of the open channel from Victoria Avenue on the east to the confluence with the Warm Creek Channel on the west. The total length of the channel surveyed and recorded is approximately three miles. The easternmost one mile of the channel is lined with concrete, including both of the segments previously recorded into the inventory, as is the westernmost 600 feet. The rest of the channel remains an unlined earthen channel, sometimes with fencing and netting along the course.

A total of seven minor concrete bridges or culverts of historical age (or possibly of historical age) along this segment of the City Creek Channel were recorded as associated features of the site. All of the bridges and culverts are of standard design and construction, and none of them demonstrate any notable characters in architecture or engineering. These seven bridges or culverts and their approximate construction dates are listed below:

Third Street crossing near Sterling Avenue, pre-1959*

Del Rosa Avenue crossing, pre-1959*

Del Rosa Drive crossing, 1968-1980*

Tippecanoe Avenue crossing, pre-1959*

Pedley Road crossing, pre-1959*

Palm Lane crossing, pre-1959*

Third Street crossing near Warm Creek Channel, 1959-1966*

* Source: aerial photographs available at historicaerials.com, 1959-1980

Historical maps and aerial photographs indicate that this segment of City Creek, a wide, unregulated wash in the late 1930s that ran further to the south in the eastern reach, had been fully channelized at least by the late 1950s. The eastern portion was evidently completed along the realigned course during the construction of what would become Norton Air Force Base in 1940-1941, and the rest of the channel likely dates to the same era.

The western end of this segment of the channel was realigned between 1959 and 1966, when the Warm Creek Channel was completely reconfigured. To the east of Victoria Avenue, approximately 500 feet of the open channel were converted into an underground culvert in 2012-2013, in preparation for the extension of that street onto the former military base in 2014-2016. The rest of the channel has undergone no major changes since 1959 except for the extension of Del Rosa Drive across it sometime between 1968 and 1980.

The City Creek Channel is a peripheral feature associated, at least partially, with the establishment of a WWII-era military base but does not demonstrate a unique or particularly close association with that event or with any other events or persons of recognized historic significance. Simple in design and utilitarian in character, the channel and its associated features, such as the bridges and culverts, do not stand out as important examples of any style, type, period, region, or method of construction, nor are they known to represent the work of a prominent architect, designer, engineer, or builder. Finally, as a late-historic-

Recorded by Daniel Ballester

Date December 10, 2019

Continuation Update

Form Prepared by Bai "Tom" Tang

Date January 29, 2019

Affiliation: CRM TECH, Colton

Project No: CRM TECH 3553

period infrastructure feature of standard construction, the channel demonstrates little potential for any important historical or archaeological information.

Based on these considerations, the 2018 and 2019 evaluations of Site 36-033079—that it is ineligible for listing in the National Register of Historic Places or the California Register of Historical Resources—appears to remain valid and appropriate.

- **UTM Coordinates: Zone** 11 ; Point A: 479,135 mE/ 3,773,994 mN
Point B: 474,708 mE/ 3,773,705 mN
- **UTM Derivation:** USGS Quad GPS

Report Citation:

Bai "Tom" Tang, Deirdre Encarnación, Daniel Ballester, Nina Gallardo, and Ben Kerridge

2020 Historical/Archaeological Resources Survey Report: City Creek Channel Project, Cities of San Bernardino and Highland, San Bernardino County, California



Typical appearance of the segment of the City Creek Channel between Victoria Avenue and Warm Creek. *Left*: concrete-lined channel at the eastern end, view to the east; *right*: earthen channel near the western end, view to the west. (Photographs taken on December 10, 2019)

*Map Name: Redlands and San Bernardino South, Calif.

*Scale: 1:24,000

*Date of Map: 1980/1996

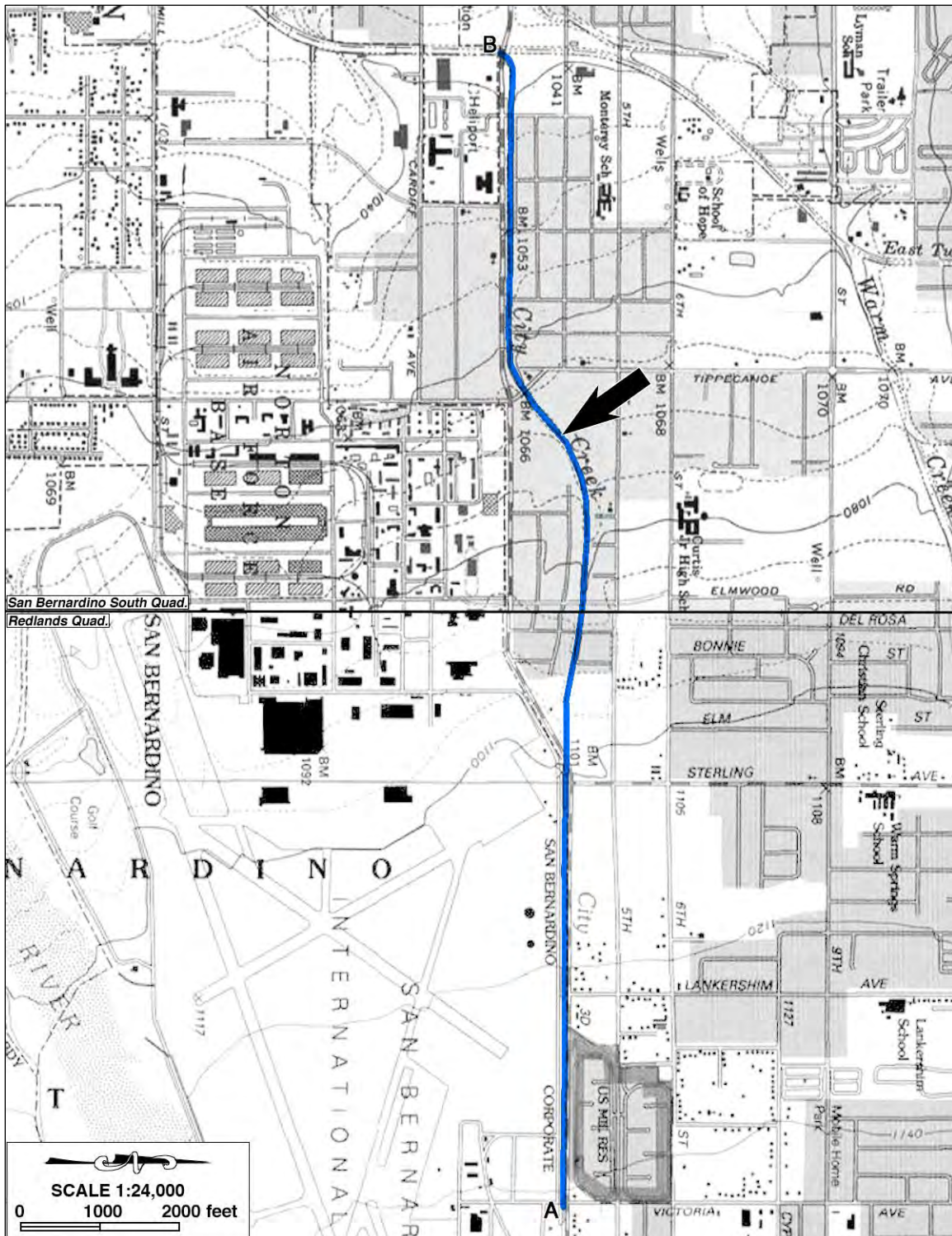

State of California--The Resources Agency
DEPARTMENT OF PARKS AND RECREATION
CONTINUATION SHEET

Primary # 36-033079

HRI #

Trinomial

Page 1 of 2

Resource name or # (Assigned by recorder) CRM TECH 3336-3H

Recorded by Daniel Ballester

Date March 22, 2019

Continuation Update

Form Prepared by Daniel Ballester

Date May 1, 2019

Affiliation: CRM TECH, Colton

Project No: CRM TECH 3453

On March 22, 2019, an approximately 700-foot-long segment of the City Creek Channel located at and near its intersection with Victoria Avenue, approximately 450 feet east of the segment recorded in 2018, was included in an intensive-level field survey. The western half of this segment, to the west of Victoria Avenue, is identical in configuration to the previously recorded segment, although some of the concrete panels lining the slopes have evidently been replaced in recent years. The eastern half have been converted into an underground culvert, and the open channel reemerges only after it crosses to the north side of Third Street some 625 feet east of Victoria Avenue. Aerial photographs available from Google Earth indicate that the alteration to the eastern half of the segment took place in 2012-2013, before Victoria Avenue was extended into the San Bernardino International Airport—and over the channel—in 2014-2016.



The segment of City Creek Channel surveyed on March 22, 2019. *Left*: remaining portion of open channel, view to the west from Victoria Avenue; *right*: culvert entrances under Victoria Avenue, view to the southeast.

- **UTM Coordinates:** Zone 11 ; 479,016-479,234 mE/ 3,773,989 mN
- **UTM Derivation:** USGS Quad GPS Google Earth

Report Citation:

Bai "Tom" Tang, Daniel Ballester, Terri Jacquemain, and Ben Kerridge
2019 Identification and Evaluation of Historic Properties: San Bernardino International Airport Land Exchange Project, City of San Bernardino, San Bernardino County, California

*Map Name: Redlands, Calif.

*Scale: 1:24,000

*Date of Map: 1996

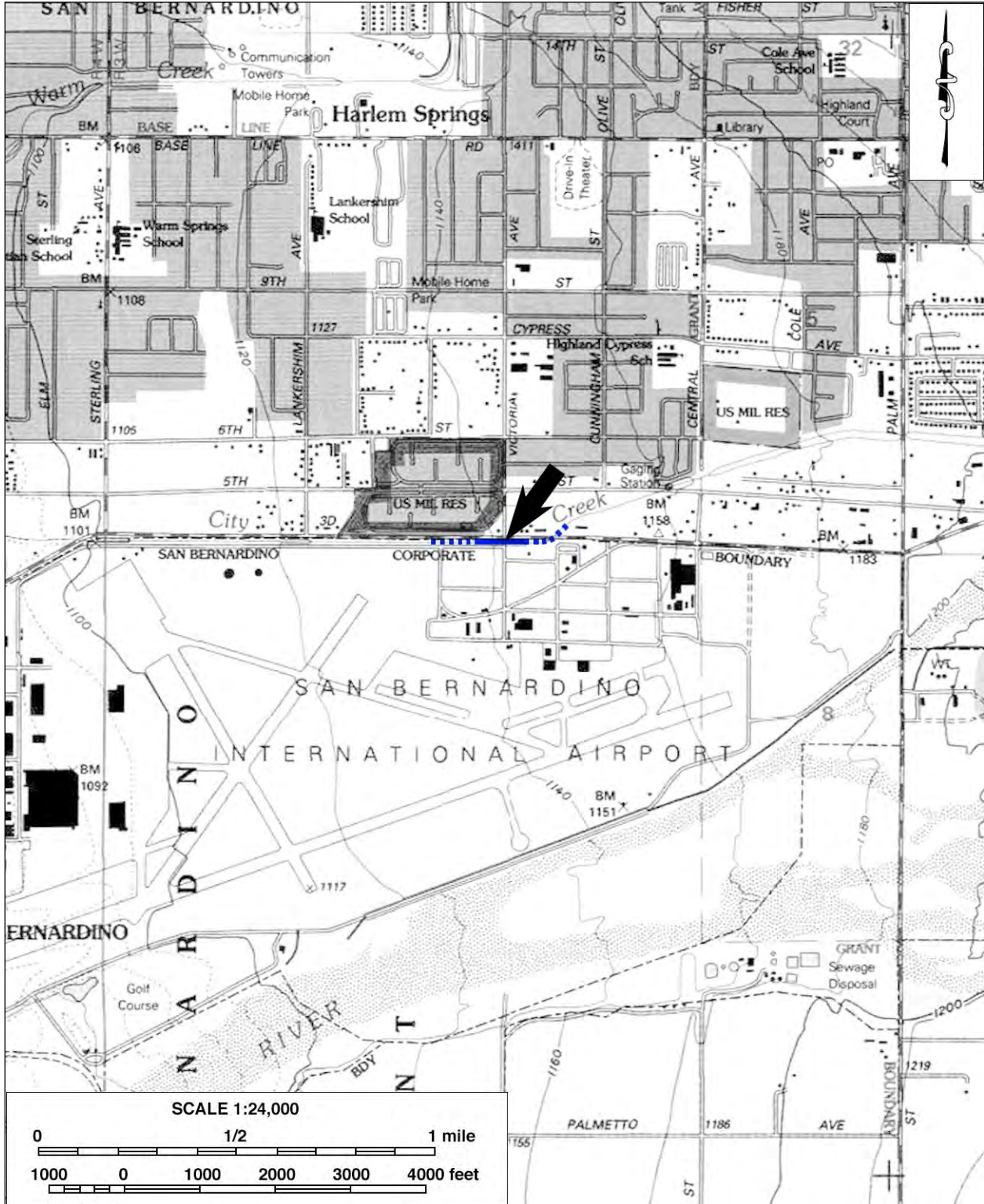

State of California--The Resources Agency
DEPARTMENT OF PARKS AND RECREATION
PRIMARY RECORD

Primary # Pending

HRI # _____

Trinomial _____

NRHP Status Code 6Z

Other Listings

Review Code _____

Reviewer _____

Date _____

Page 1 of 4*Resource Name or # (Assigned by recorder) CRM TECH 3336-3H

- P1. Other Identifier:** City Creek Channel
- *P2. Location:** Not for Publication Unrestricted *a. County San Bernardino
and (P2b and P2c or P2d. Attach a Location Map as necessary.)
- *b. **USGS 7.5' Quad** Redlands, Calif. **Date** 1967, photorevised 1996
T1S; R3W; S.B. B.M. (within the Rancho San Bernardino land grant)
Elevation: Approximately 1,111-1,134 feet above mean sea level (including the depth of the channel)
- c. Address** N/A **City** San Bernardino **Zip** 92408
- d. UTM:** (Give more than one for large and/or linear resources) **Zone** 11 ; A: 478125 mE/ 3774000 mN;
B: 478880 mE/ 3774000 mN.
- UTM Derivation:** USGS Quad GPS Google Earth
- e. Other Locational Data:** (e.g., parcel #, directions to resource, etc., as appropriate) On the northern edge of the San Bernardino International Airport (formerly Norton Air Force Base), 26-28 feet south of Third Street, between Sterling Avenue and Victoria Avenue
- *P3a. Description:** (Describe resource and its major elements. Include design, materials, condition, alterations, size, setting, and boundaries) The site consists of a segment of concrete-walled drainage channel that contains the realigned City Creek, a tributary of the Santa Ana River. The segment recorded at this location features an open earthen bottom and gently sloping side walls lined with 3.5-inch-thick concrete panels (see p. 2 for dimensions). The channel was evidently built in the early 1940s in association with the construction of what would become Norton Air Force Base on the adjacent property to the south (now the San Bernardino International Airport), which required the realignment of City Creek from its natural course further the south.
- *P3b. Resource Attributes:** (List attributes and codes) HP20: Canal/aqueduct
- *P4. Resources Present:** Building Structure Object Site District Element of District
 Isolate Other
- P5a. Photograph or Drawing** (Photograph required for buildings, structures, and objects.) (See p. 2 and p. 4)
- P5b. Description of Photo:** (view, date, accession #) _____
- *P6. Date Constructed/Age and Sources:** Historic Prehistoric Both Early 1940s?
- *P7. Owner and Address:** San Bernardino County Flood Control District, 320 North E Street, #510, San Bernardino, CA 92401
- *P8. Recorded by:** (Name, affiliation, and address) Daniel Ballester, CRM TECH, 1016 East Cooley Drive, Suite A/B, Colton, CA 92324
- *P9. Date Recorded:** May 16, 2018
- *P10. Survey Type:** (Describe) Intensive-level survey for Section 106 and CEQA compliance purposes
- *P11. Report Citation:** (Cite survey report and other sources, or enter "none.") Bai "Tom" Tang, Michael Hogan, Ben Kerridge, and Daniel Ballester (2018): Identification and Evaluation of Historic Properties: Proposed Eastgate Air Cargo Facility, City of San Bernardino, San Bernardino County, California
- *Attachments:** None Location Map Sketch Map Continuation Sheet Building, Structure, and Object Record
 Archaeological Record District Record Linear Resource Record Milling Station Record Rock Art Record
 Artifact Record Photograph Record Other (List): _____

State of California--The Resources Agency
DEPARTMENT OF PARKS AND RECREATION
LINEAR FEATURE RECORD

Primary #

HRI #

Trinomial _____

Page 2 of 4*Resource Name or # (Assigned by recorder) CRM TECH 3336-3HL1. **Historic and/or Common Name:** City Creek ChannelL2a. **Portion Described:** Entire Resource Segment Point Observation **Designation:** _____

b. **Location of Point or Segment:** (Provide UTM coordinates, legal description, and any other useful locational data. Show the area that has been field inspected on a Location Map.) The segment recorded extends approximately 2,480 feet to the west along the north side of Perimeter Road from the intersection of Hangar Way.

L3. **Description:** (Describe construction details, materials, and artifacts found at this segment/point. Provide plans/sections as appropriate.) See Item P3a.

L4. **Dimensions:** (In feet for historic features and meters for pre-historic features)

a. **Top Width** 51-66 feet

b. **Bottom Width** 32-35 feet

c. **Height or Depth** 4.0-5.5 feet

d. **Length of Segment** 2,480 feet

L5. **Associated Resources:** _____

L4e. **Sketch of Cross-Section** (Include scale)

Facing: _____

See p. 4

L6. **Setting** (Describe natural features, landscape characteristics, slope, etc. as appropriate) The site is situated on the outskirts of the City of San Bernardino, between the perimeter fence of the San Bernardino International Airport and the Third Street right-of-way. The surrounding area contains scattered development and large expanses of vacant land, including some parcels where buildings associated with the former military base have been demolished since the closure of the base in 1994.

L7. **Integrity Considerations:** The overall configuration of the channel does not appear to have been altered significantly, although some of the concrete side slope panels are clearly of a much later vintage. As a working component of the modern flood-control infrastructure, however, the channel does not demonstrate any distinctively historical characteristics. In addition, it lacks any documented association with significant historic figures or events, archaeological data potential, or special merits in design, construction, engineering, or esthetics. Therefore, it does not appear eligible for listing in the National Register of Historic Places or the California Register of Historical Resources.

L8a. **Photograph, Map or Drawing**



L8b. **Description of Photo, Map, or Drawing** (View, scale, etc.) Photo taken on November 27, 2018; view to the east

L9. **Remarks:** _____

L10. **Form Prepared by:** (Name, affiliation and address): Nina Gallardo, CRM TECH, 1016 East Cooley Drive, Suite A/B, Colton, CA 92324

L11. **Date:** November 27, 2018

State of California - Natural Resources Agency
DEPARTMENT OF PARKS AND RECREATION
LOCATION MAP

Primary # _____
HRI# _____
Trinomial _____

*Map Name: Redlands and San Bernardino South, Calif.

*Scale: 1:24,000

*Date of Map: 1980/1996

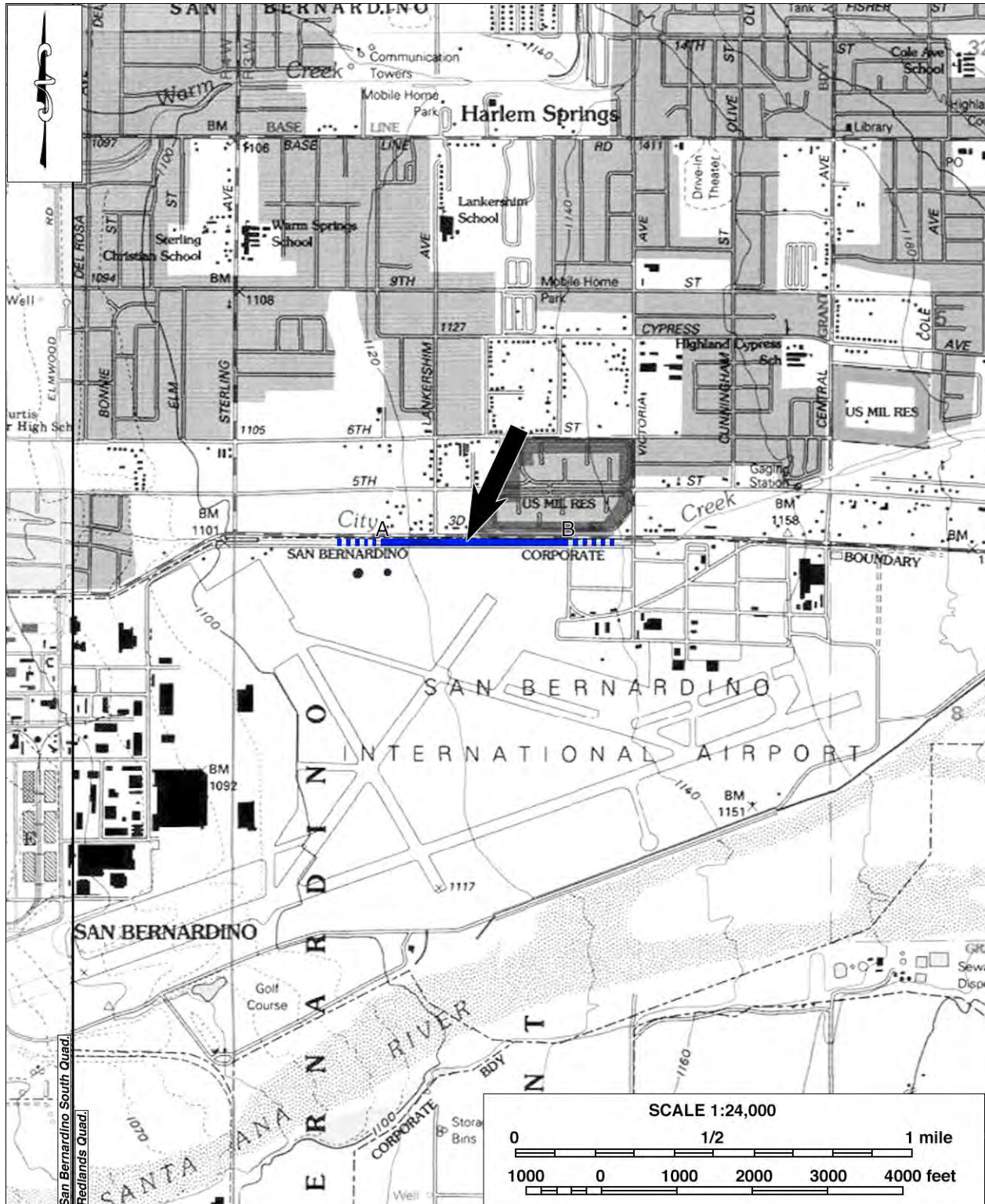

State of California - Natural Resources Agency
 DEPARTMENT OF PARKS AND RECREATION
CONTINUATION SHEET

Primary # _____
 HRI# _____
 Trinomial _____

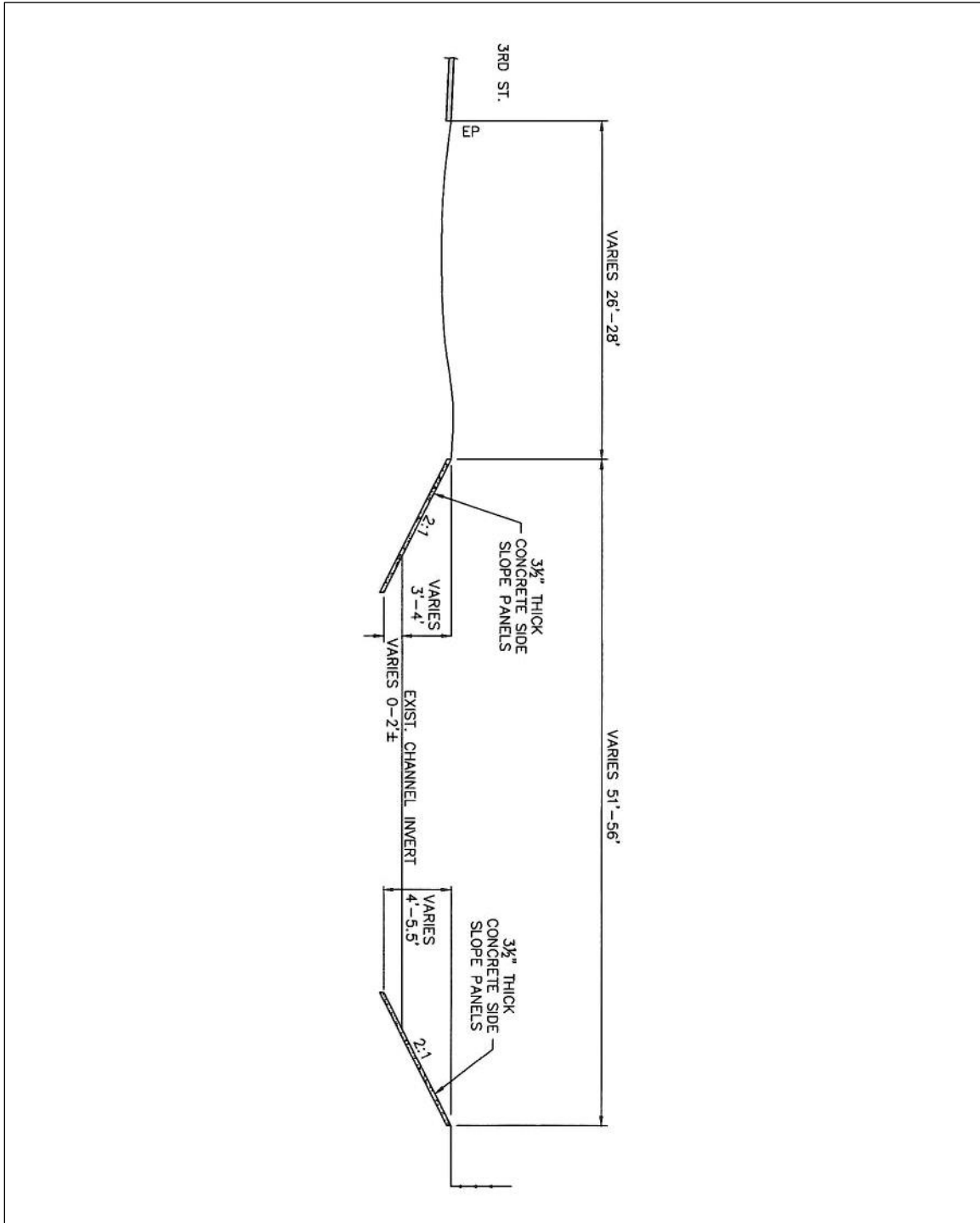

Sketch of cross-section, facing East

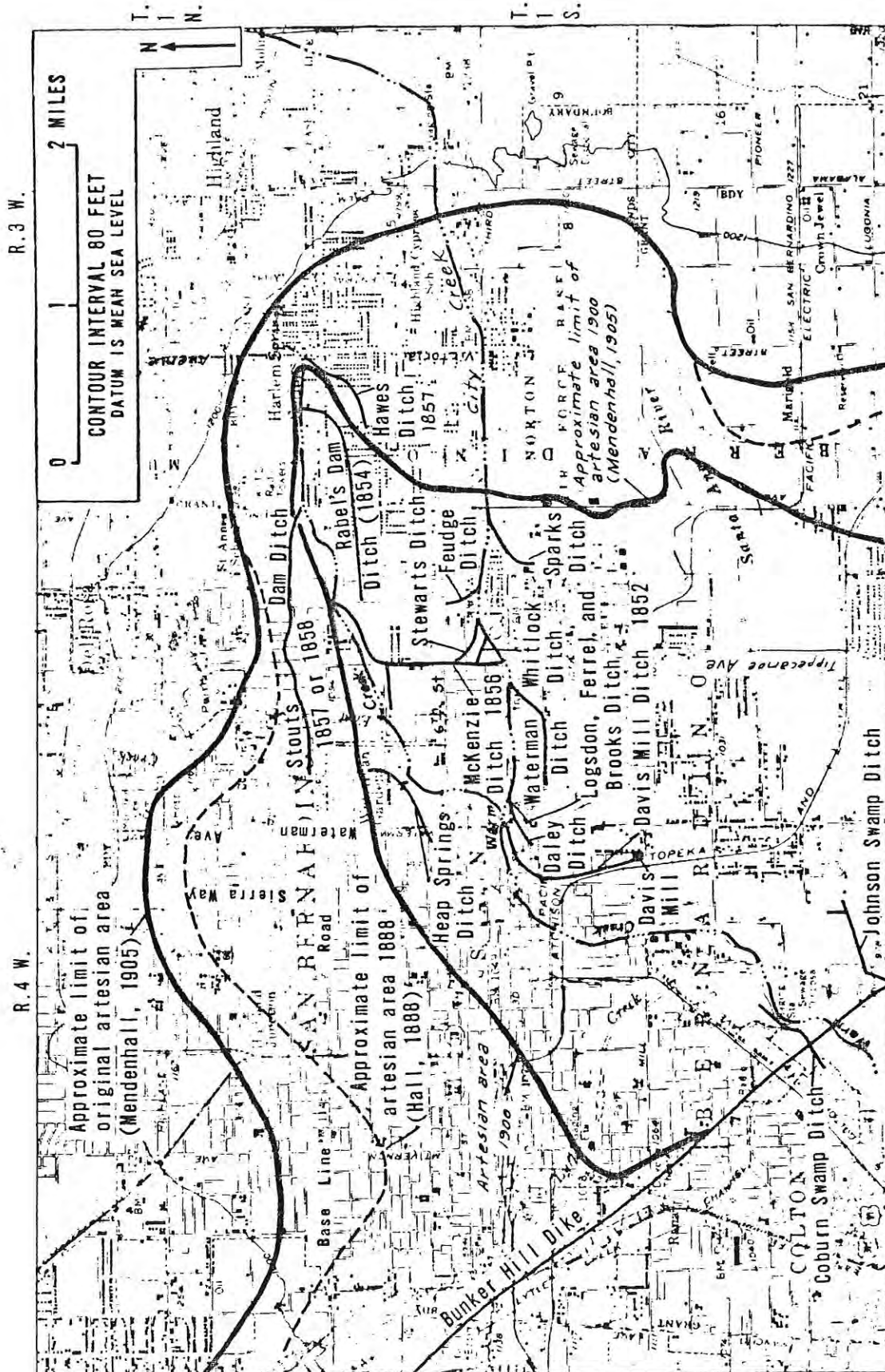

Base from U.S. Geological Survey San Bernardino and Redlands 1954, 1:62 500

FIGURE 21.--Diversions from Warm Creek.

3910

P1074-91-11

The control of Rabel's dam ditch passed from the Mormons, probably in 1857 or 1858 (Beattie, 1939, p. 290), when many of them returned to Salt Lake City. The Rancho San Bernardino was then divided and sold to individual owners, who maintained the ditch. In October 1895 an agreement between the ditch owners and the Riverside Water Co. provided that owners of rights in the ditch were entitled to 250 miner's inches of the natural flow of Warm Creek (Lippincott, 1902a, p. 24). To measure this flow the company, as part of the agreement, installed a permanent weir at the head of the ditch. In 1899 the weir was removed and the upper part of the ditch was lowered with the consent of the Riverside Water Co. (Lippincott, 1902a, p. 24). This increased the flow for a short time, but the flow soon dropped to less than the original discharge.

At about the time the above-mentioned weir was installed, the owners of Rabel's dam ditch decided that they would have better control of their water rights and distribution system by incorporating. Accordingly, on October 18, 1897, they organized the Warm Creek Water Co. Their service area, in 1900, consisted of 400 irrigated acres of alfalfa, vegetables, and other garden produce (Lippincott, 1902a, p. 24).

As mentioned on page 51, the artesian wells, drilled to supplement the natural flow from the basin, greatly reduced the flow of the springs at the head of Warm Creek. The measured flow in the ditch in August 1899 was only 0.94 ft³/s, and in June of the following year the flow dropped to 0.35 ft³/s (Lippincott, 1902a, p. 29). The decrease in flow from about 5 ft³/s in the early 1880's to less than 0.5 ft³/s in 1900 reflects the general decline in surface flow of all the streams on the valley floor whose source was within the artesian area. The natural flow of Warm Creek continued to decline in the twentieth century. When in March 1952, the Meeks and Daley Water Co. purchased the rights in Rabel's dam ditch, there was no flow in Warm Creek at the ditch heading (oral commun., Meeks and Daley Water Co., 1967). After this purchase of the major part of the outstanding stock of the Warm Creek Water Co., the company was dissolved.

McKenzie Ditch

The McKenzie ditch was built by Mormon settlers about 1856 (Hall, 1888, p. 273). The point of diversion from Warm Creek was on the south side of the creek about midway between present-day Sterling and Tippecanoe Avenues (fig. 21). In the early 1880's the owners of the ditch maintained a tight wooden dam in the stream and diverted the flow through an open ditch whose capacity was about 200 miner's inches. During that period water from the ditch irrigated about 240 acres of land west of Tippecanoe Avenue, between Warm and City Creeks, and 85 acres south of City Creek. Water was carried across City Creek in a flume (Hall, 1888, p. 272). The irrigated areas included orchards, vineyards, and fields of alfalfa and summer crops.

2

Prior to 1880, the water supply was generally adequate for all needs, but in the next few years there were brief periods when the supply fell short of the irrigation requirements (Hall, 1888, p. 72). In 1899 the ditch diverted 2 ft³/s and in June 1900 it diverted 1.57 ft³/s (Lippincott, 1902a, p. 30). In 1900 the irrigated area was about 300 acres, principally for growing alfalfa and garden crops.

In 1900 the owners of the McKenzie ditch claimed all the water in Warm Creek at their dam, but the Riverside Water Co. claimed that the McKenzie right was limited to 100 miner's inches (Lippincott, 1902a, p. 25). The controversy was settled in March 1901 when a court decree established the rights of the ditch owners to 209 miner's inches of the natural flow of Warm Creek, with no right to exceed that quantity by pumping (written commun., W. P. Rowe and Son, 1967).

The discharge records of Warm Creek at Base Line Road show that flow for the months of June to September, during the mid-1940's, ranged from 0.2 to 3.4 ft³/s, with a probable average of 1 ft³/s or less during those irrigation seasons. A combination of diminishing flow in Warm Creek and subdivision of the service area for residential use had eliminated the diversion, prior to the purchase of the water rights of the ditch in 1943 by the Riverside Water Co. (written commun., city of Riverside, 1967).

Stout's Dam Ditch or Shay Ditch

Stout's dam ditch, later known as the Shay ditch, diverted upstream from a tight dam in the Warm Creek channel, a short distance east of Sterling Avenue (fig. 21). The original ditch followed a course generally parallel to Base Line Road, extending west to, or possibly beyond, the East Twin Creek channel. The ditch was built in 1857 or 1858, and in 1881 its capacity was about 100 miner's inches (Hall, 1888, p. 275). At some later date the ditch was apparently enlarged.

The area irrigated from Stout's dam ditch lay between the ditch and Base Line Road. The irrigated acreage was 140 acres in 1881, and increased to 210 acres in 1885 (Hall, 1888, p. 271). During that period the irrigated crops included deciduous fruits, grapes, alfalfa, and summer crops.

The water supply for the ditch was not as copious as that for Rabel's dam ditch, it being subject to the prior rights of both Rabel's dam ditch and the McKenzie ditch. The supply was principally outflow from a swamp north of Warm Creek and east of the diversion dam. During the dry period following 1862, the supply was insufficient to meet irrigation needs (Hall, 1888, p. 271). In 1895, by agreement with the Riverside Water Co., the owners of the ditch were entitled to divert 112.5 miner's inches of water from Warm Creek (Lippincott, 1902a, p. 24).

of 25 miner's inches of water to the ditch owners, thus maintaining a supply of water for the area irrigated by Heap Springs ditch. In the early 1930's the Riverside Water Co. purchased this right to 25 miner's inches, and thus eliminated one more small diversion in the Warm Creek basin (oral commun., city of Riverside, 1967).

Spark's Ditch

Spark's ditch diverted water from the south side of City Creek (a tributary of Warm Creek) near Sterling Avenue (fig. 21). The water was used to irrigate 20 acres of land west of Sterling Avenue and south of City Creek. In 1880 the capacity of the ditch was about 25 miner's inches (Hall, 1888, p. 273). Although Lippincott (1902a, b) does not mention Spark's ditch, Mendenhall (1905, pl. XII) indicates that it was still in use in 1904.

Stewart's Ditch

Stewart's ditch diverted water from the north side of City Creek about midway between Sterling and Tippecanoe Avenues (fig. 21), for the irrigation of about 47 acres of land east of Tippecanoe Avenue (Hall, 1888, p. 273). At the time of Hall's investigation, the capacity of the ditch was about 35 miner's inches.

Whitlock Ditch

The Whitlock ditch diverted flow from the north side of City Creek (fig. 21). The ditch was used to irrigate vegetable gardens in the area, and its surplus water discharged into the McKenzie ditch. Records for the ditch are meager. On June 29, 1898, its flow was 12 miner's inches (Lippincott, 1902a, p. 26). The diminishing flow in the artesian basin of City Creek caused the abandonment of this diversion.

Feudge Ditch

The Feudge ditch probably diverted water from the north side of City Creek, upstream from Stewart's ditch (fig. 21). The water was used to irrigate a small area north of City Creek and east of Stewart's ditch, as indicated on a map by Hall (1888, San Bernardino sheet). Neither Hall nor Lippincott mentioned the Feudge ditch in the text of their reports.

RSBR

1H LA → SONORA RD P36-016417	29H RABEL'S DITCH
2H CUCAMONGA → CAJON PASS RD	30H STOUT'S DAM DITCH
3H BASELINE RD P36-01547	31H PLUNGE CR. DIVERSION DITCH
4H SAWPIT CYN RD	32H BASELINE DITCH
5H W. CAJON CYN RD	33H RIALTO CANAL
6H CAJON PASS → HORSETHIEF CYN RD	34H OLD TOWN DITCH
7H - NOW SBR-8092H	35 ELEPHANT MTN QUARRY
8H - NOW SBR-8094H	36 - NOW SBR-7694H
9H - SANTA ANA CYN POWER LINES ¹⁸⁷⁵⁹	37 - NOW SBR-8857H
10H - NOW SBR-7051H	38H Boulder Dam → SB Power Line ^{SBR-12,315H}
11H - NOW SBR-6544H	39H KRAMER → VICTOR POWERLINE ^{SBR-10346H}
12H E. HIGHLANDS RANCH	40 - no record
13H VAN DUSEN RD ^{11/99} SBR-4276H	41 - LITHIC REDUCTION - F. KLOWD
14 INDIAN VILLAGE SITE, RIALTO	42 - ROGERS M-75
15 INDIAN VILLAGES - Moj R-Park	43H HARLETT MOTOR RD ^{10/02} SBR-10820H
16 INDIAN VILLAGE SITE, APPLE VALLEY	44 - ROGERS M-120
17H DE ANZA TRAIL ^{CPII-27} P36-015980 ^{1/08}	45H DEATH VLY MOUND RD
18H TRI CITY THEATER, LOHALINDA	46H ^{MT} SAN ANTONIO MINES & RESERVOIR
19H ^{BRIDGE OF} DEVIL CYN TOLL RD 36-013421 ^{7/07}	47 TOPOCK TRAIL
20 no record	48H LOHALINDA SURVEY STRUCTURES
21H SUNNYSIDE DITCH - SOUTH FORK	49H EUCLID AVE
22H JUDSON-BROWN DITCH 13549H ^{8/07}	50H MULT HIST STRUCTURES - FONTANA
23H - NOW SBR-8546H	51 SBR-8630 → 39
24 - PINNACLES SITE - SEARLES DRY LK	52 AFTON CYN TRAILS
25 no record	53 ROGERS M-62 & 63
26H TIMBER DITCH	54 ROGERS M-59
27H NORTH FORK DITCH - 1856	55 ROGERS M-60 & 60A
28H SOUTH FORK OF SANTA ANA 1877	56 SPERRY WASH VILLAGE SITES

12 WATER FACILITIES, SANTA ANA RIVER BASIN, CALIF., 1810-1968

Water commissions played an important role in regulating those water rights. As early as 1854, the California legislature, in seeking to promote the orderly development of irrigated agriculture in the State, passed an act providing for "board(s) of commissioners...to regulate water courses," whose duty would be "to apportion the (irrigating) water of the streams in their districts among the inhabitants thereof, and authorize the construction of ditches" when proper application was made.

On the pages that immediately follow, there are numerous references to Hall (1888) and Beattie (1951). In their histories of the water development of the Santa Ana River above Waterman Avenue, San Bernardino (fig. 4), Hall and Beattie disagree at times on the location of points of diversion and on dates when ditches were established. Beattie's account is given more credence here because he had access to Hall's report when he was doing his research and would be unlikely to differ with Hall for frivolous reasons.

North Fork Ditch

Two groups of non-Mormon settlers established communities east of San Bernardino in the early 1850's. Referred to present streets, one community was south of Mill Street between Waterman and Tippecanoe Avenues, and the other along Sixth Street between Waterman and Sterling Avenues (Beattie and Beattie, 1939, p. 241). The former was known as the Timber Settlement and the latter as the City Creek Settlement (fig. 4). The high water table in the area enabled deep-rooted crops to grow readily, but shallow-rooted crops such as corn and garden crops required supplemental water.

In May 1856 the settlers in the two communities combined their efforts in the construction of a dam in the Santa Ana River and two diversion ditches to carry water to the settlements. The approximate location of the ditch heading and ditches is shown in figure 4. The Timber Settlement was served by the Timber ditch and the City Creek Settlement was served by the North Fork ditch. ←

At about the same time, two Mormon groups established settlements near the City Creek and Timber Settlements. One group settled on the site of the present city of San Bernardino, and the other group settled on the south side of the Santa Ana River, northwest of San Gabriel Mission Asistencia. The latter settlement became known as Old San Bernardino. In the autumn of 1856, the settlers of Old San Bernardino, under the leadership of Bishop Nathan C. Tenney, built the Tenney ditch (figs. 4 and 5) from the south side of the river to irrigate land to the north of that irrigated by the Mill Creek zanja, or old mission ditch (Beattie, 1951, p. 3).

Because the Tenney ditch heading was upstream from the earlier established heading of the diversions to the City Creek and Timber Settlements--North Fork and Timber ditches--the users of those two ditches immediately protested to the board of water commissioners. The board decreed that all flow belonged to the Timber and North Fork ditches and ordered Tenney to cease diverting any flow from the river. By order of the board a tight dam was built across the head of the Tenney ditch and that terminated the Tenney diversion.

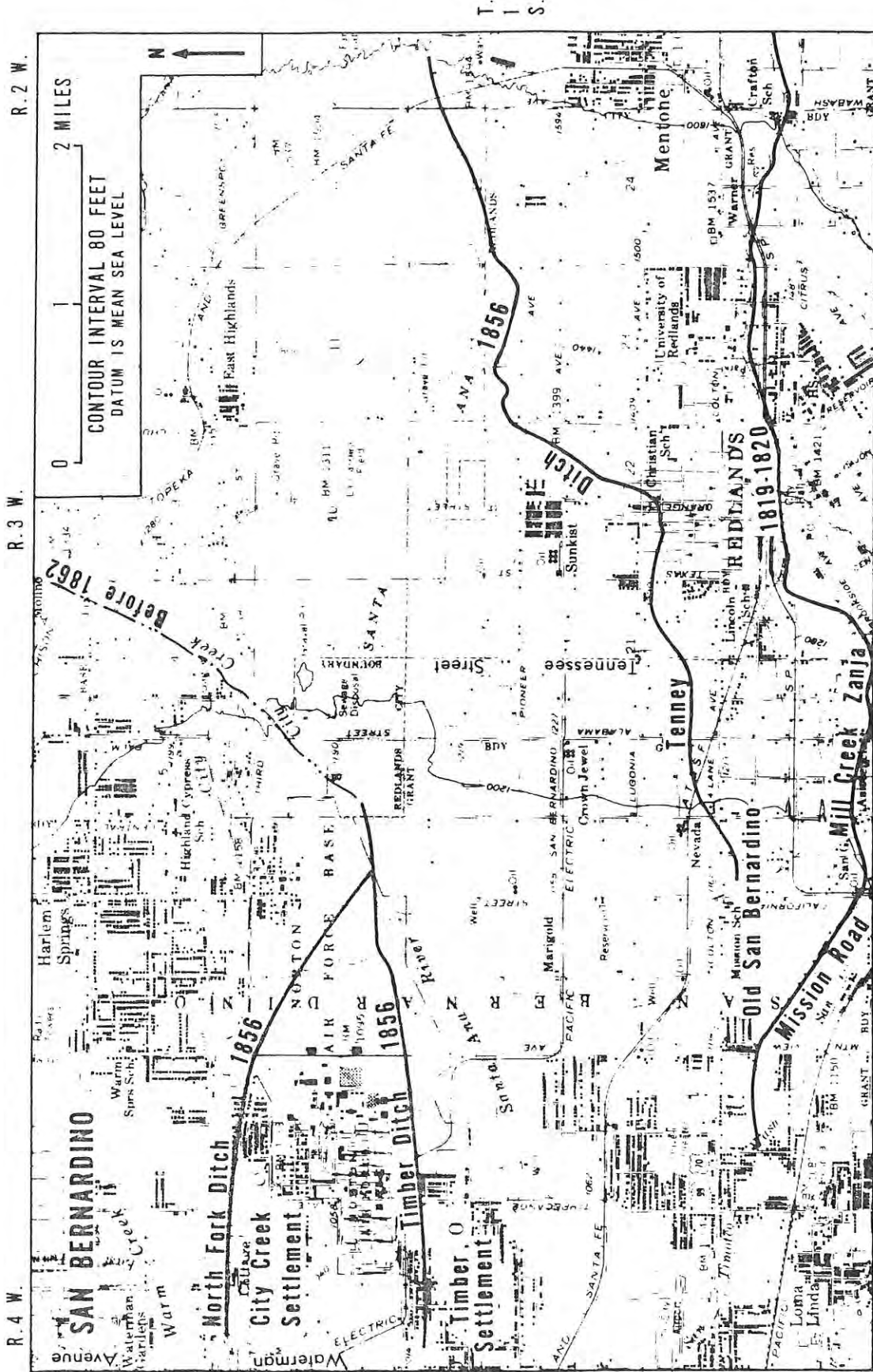

Base from U.S. Geological Survey San Bernardino and Redlands 1954. 1:62,500

FIGURE 4.--North Fork, Timber, and Tenney ditches.